



## Magnetventilsteckverbinder Bauform C *Solenoid valve connectors size C*

### Gerätesteckdosen Magnetventilsteckdosen

- Schutzart IP65/IP67 <sup>1)</sup>
- 2+PE, 3+PE
- Industrie
- DIN EN 175301-803 (ersetzt DIN 43650)

### Female power connectors Female solenoid valve connectors

- Degree of protection IP65/IP67 <sup>1)</sup>
- 2+PE, 3+PE
- Industrial standard
- DIN EN 175301-803 (replaces DIN 43650)



**Aufbau des Steckverbinders:**  
*Construction of the connector:*

Gerätesteckdose DIN/Industrie  
 mit Gerätestecker  
*Female power connector DIN/  
 industrial standard with  
 male power connector*

Magnetventilsteckdose  
 DIN/Industrie  
*Female solenoid valve connector  
 DIN/industrial standard*



- ü
- Ti
- SI IP40
- SI IP67
- Bejonett
- MPP IP67
- PP IP67
- M9 IP40
- M9 IP67
- SI IP67
- Bejonett
- PP IP67
- M16 IP40
- M16 IP67
- M23
- Bejonett
- M25
- RD24
- RD30
- M5
- M8
- M12-A
- VL
- Verteiler
- M12-B
- M12-D
- M12-US
- M18
- 7/8"
- BF-A
- BF-B
- BF-C
- R

**Magnetventilsteckverbinder Bauform C Serie 235**  
**Solenoid valve connectors size C series 235**

**Industrie**  
**Industrial standard**

Bezeichnung  
Description

Gerätesteckdose Industrie  
Female power connector industrial standard

Gerätesteckdose Industrie,  
metrisches Gewinde M12  
Female power connector industrial standard,  
metric thread M12

Abbildung  
Figure



Maßzeichnung  
Drawing

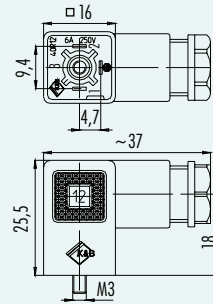
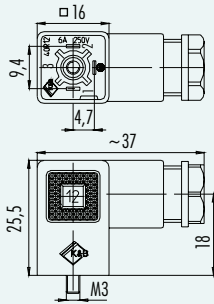

Bestell-Nr.  
Ordering-No.

Polzahl Contacts	Kabeldurchlass (mm) Cable outlet (mm)	Bestell-Nr. Ordering-No.
2+PE	4-6	43-1930-000-03
3+PE	4-6	43-1932-000-04

Polzahl Contacts	Kabeldurchlass (mm) Cable outlet (mm)	Bestell-Nr. Ordering-No.
2+PE	4-6	43-1930-004-03
3+PE	4-6	43-1932-004-04

Technische Daten  
Specifications

Polzahl	2+PE/3+PE	Number of contacts
Steckverbinder Verriegelung	Zentrierschraube/central screw	Connector locking system
Anschlussart	Schrauben/screw	Termination
Anschlussquerschnitt	min. 0,14 mm <sup>2</sup> (min. AWG 26), max. 0,75 mm <sup>2</sup> (max. AWG 18)	Wire gauge
Kabeldurchlass	4-6 mm	Cable outlet
Schutzart	IP65	Degree of protection
Mechanische Lebensdauer	> 50 Steckzyklen/> 50 mating cycles	Mechanical operation
Obere Grenztemperatur	+ 120 °C mit Dichtung 16-8106-000/with seal 16-8106-000	Upper temperature
Untere Grenztemperatur	- 20 °C mit Dichtung 16-8106-000/with seal 16-8106-000	Lower temperature
Bemessungsspannung	250 V	Rated voltage
Bemessungs-Stoßspannung	800 V	Rated impulse voltage
Verschmutzungsgrad	3	Pollution degree
Überspannungskategorie	III	Overvoltage categorie
Isolierstoffgruppe	III	Material group
Bemessungsstrom (40 °C)	6 A	Rated current (40 °C)
Durchgangswiderstand	≤ 15 mΩ	Contact resistance
Material Kontakt	CuSn (Bronze/bronze)	Material of contact
Kontaktoberfläche	Ni (Nickel/nickel)	Contact plating
Material Kontaktkörper	PA (UL 94 HB)	Material of contact body
Material Gehäuse	PA (UL 94 HB)	Material of housing

**Magnetventilsteckverbinder Bauform C Serie 230**  
**Solenoid valve connectors size C series 230**

**DIN**  
**DIN**

Bezeichnung  
Description

Gerätesteckdose **DIN EN 175301-803**  
 Female power connector **DIN EN 175301-803**

Gerätesteckdose **DIN EN 175301-803**,  
**metrisches Gewinde M12**  
 Female power connector **DIN EN 175301-803**,  
**metric thread M12**

Abbildung  
Figure



Maßzeichnung  
Drawing

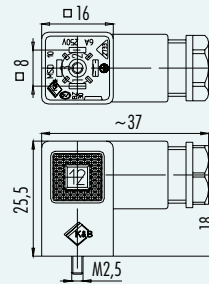
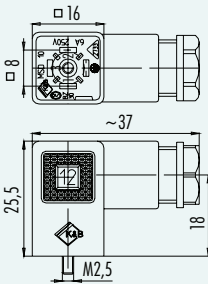

Bestell-Nr.  
Ordering-No.

Polzahl Contacts	Kabeldurchlass (mm) Cable outlet (mm)	Bestell-Nr. Ordering-No.		Polzahl Contacts	Kabeldurchlass (mm) Cable outlet (mm)	Bestell-Nr. Ordering-No.	
2+PE	4-6	43-1900-000-03	Ⓢ	2+PE	4-6	43-1900-004-03	Ⓢ
3+PE	4-6	43-1902-000-04	Ⓢ	3+PE	4-6	43-1902-004-04	Ⓢ

Technische Daten  
Specifications

	<b>2+PE/3+PE</b>	
Polzahl	<b>2+PE/3+PE</b>	Number of contacts
Steckverbinder Verriegelung	Zentrierschraube/central screw	Connector locking system
Anschlussart	schrauben/screw	Termination
Anschlussquerschnitt	min. 0,14 mm <sup>2</sup> (min. AWG 26), max. 0,75 mm <sup>2</sup> (max. AWG 18)	Wire gauge
Kabeldurchlass	4-6 mm	Cable outlet
Schutzart	IP65	Degree of protection
Mechanische Lebensdauer	> 50 Steckzyklen/> 50 mating cycles	Mechanical operation
Obere Grenztemperatur	+ 120 °C mit Dichtung 16-8106-000/with seal 16-8106-000	Upper temperature
Untere Grenztemperatur	- 20 °C mit Dichtung 16-8106-000/with seal 16-8106-000	Lower temperature
Bemessungsspannung	250 V	Rated voltage
Bemessungs-Stoßspannung	800 V	Rated impulse voltage
Verschmutzungsgrad	3	Pollution degree
Überspannungskategorie	III	Overvoltage categorie
Isolierstoffgruppe	III	Material group
Bemessungsstrom (40°C)	6 A	Rated current (40 °C)
Durchgangswiderstand	≤ 15 mΩ	Contact resistance
Material Kontakt	CuSn (Bronze/bronze)	Material at contact
Kontaktfläche	Ni (Nickel/nickel)	Contact plating
Material Kontaktkörper	PA (UL 94 HB)	Material of contact body
Material Gehäuse	PA (UL 94 HB)	Material of housing

## Magnetventilsteckverbinder Bauform C Serie 235

### Solenoid valve connectors size C series 235

## Industrie

### Industrial standard

#### Bezeichnung

Description

Magnetventilsteckdose **Industrie**,  
Kabel angespritzt PUR 0,75mm<sup>2</sup>  
Female solenoid valve connector **industrial standard**,  
moulded cable PUR 0,75mm<sup>2</sup>

#### Abbildung

Figure



Magnetventilsteckdose **Industrie**,  
Kabel angespritzt PUR 0,75mm<sup>2</sup>, **beschaltet, LED**  
Female solenoid valve connector **industrial standard**,  
moulded cable PUR 0,75mm<sup>2</sup>, **wired, LED**



#### Maßzeichnung

Drawing

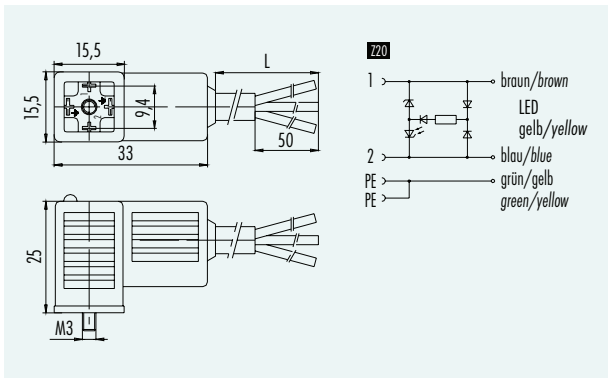
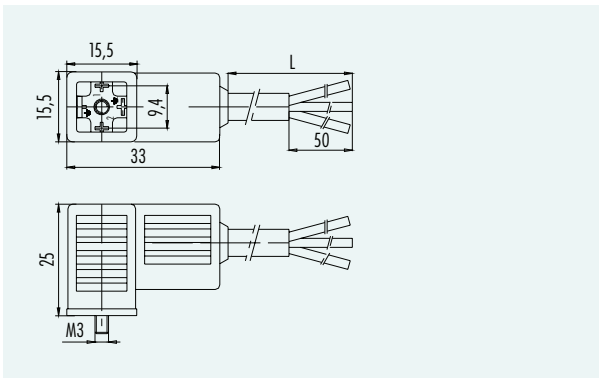

#### Bestell-Nr.

Ordering-No.

Polzahl Contacts	Kabellänge (m) Cable length (m)	Spannung Voltage	Strom Rated current	Bestell-Nummer Ordering-Number
2+PE	3	250 V	6 A	33-1313-300-000
2+PE	5	250 V	6 A	33-1313-500-000
3+PE	3	250 V	6 A	33-1314-300-000
3+PE	5	250 V	6 A	33-1314-500-000

Polzahl Contacts	Kabellänge (m) Cable length (m)	Spannung Voltage	Strom Rated current	Bestell-Nummer Ordering-Number
2+PE Z20	3	24 V	4 A	33-1313-300-520
2+PE Z20	5	24 V	4 A	33-1313-500-520

#### Technische Daten

Specifications

Polzahl	2+PE/3+PE	Number of contacts
Steckverbinder Verriegelung	Zentrierschraube/central screw	Connector locking system
Anschlussart	löten, crimpen, am Kabel angespritzt/solder, crimp, moulded	Termination
Anschlussquerschnitt	0,75 mm <sup>2</sup> (AWG 20)	Wire gauge
Kabeldurchlass	-	Cable outlet
Schutzart	IP67	Degree of protection
Mechanische Lebensdauer	> 50 Steckzyklen/> 50 mating cycles	Mechanical operation
Obere Grenztemperatur	+ 85 °C	Upper temperature
Untere Grenztemperatur	- 20 °C	Lower temperature
Bemessungsspannung	250 V, 24 V	Rated voltage
Bemessungs-Stoßspannung	800 V, 4000 V	Rated impulse voltage
Verschmutzungsgrad	3	Pollution degree
Überspannungskategorie	III	Overvoltage categorie
Isolierstoffgruppe	III	Material group
Bemessungsstrom (40 °C)	6 A, 4 A	Rated current (40 °C)
Durchgangswiderstand	≤ 15 mΩ	Contact resistance
Material Kontakt	CuSn (Bronze/bronze)	Material of contact
Kontaktoberfläche	Ag (Silber/silver)	Contact plating
Material Kontaktkörper	PBT	Material of contact body
Material Gehäuse	PBT	Material of housing

## Magnetventilsteckverbinder Bauform C Serie 230

### Solenoid valve connectors size C series 230

DIN  
DIN

Bezeichnung  
Description

Magnetventilsteckdose **DIN EN 175301-803**,  
Kabel angespritzt PUR 0,75mm<sup>2</sup>  
Female solenoid valve connector **DIN EN 175301-803**,  
moulded cable PUR 0,75mm<sup>2</sup>

Magnetventilsteckdose **DIN EN 175301-803**,  
Kabel angespritzt PUR 0,75mm<sup>2</sup>, **beschaltet, LED**  
Female solenoid valve connector **DIN EN 175301-803**,  
moulded cable PUR 0,75mm<sup>2</sup>, **wired, LED**

Abbildung  
Figure



Maßzeichnung  
Drawing

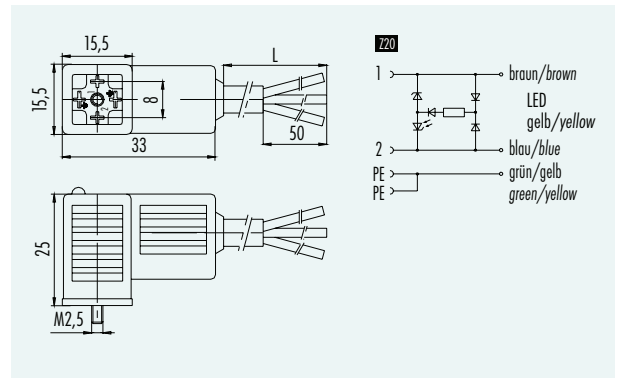
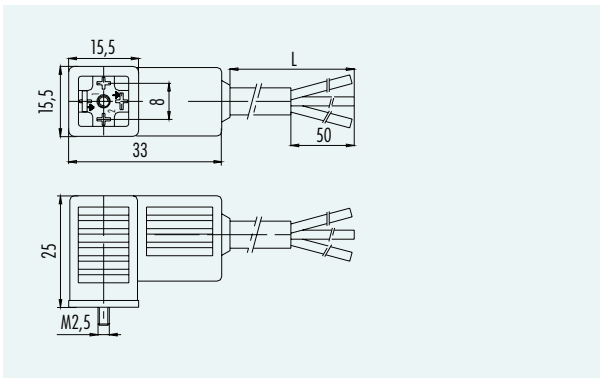

Bestell-Nr.  
Ordering-No.

Polzahl Contacts	Kabellänge (m) Cable length (m)	Spannung Voltage	Strom Rated current	Bestell-Nummer Ordering-Number
2+PE	3	250 V	6 A	34-1313-300-000
2+PE	5	250 V	6 A	34-1313-500-000
3+PE	3	250 V	6 A	34-1314-300-000
3+PE	5	250 V	6 A	34-1314-500-000

Polzahl Contacts	Kabellänge (m) Cable length (m)	Spannung Voltage	Strom Rated current	Bestell-Nummer Ordering-Number
2+PE Z20	3	24 V	4 A	34-1313-300-520
2+PE Z20	5	24 V	4 A	34-1313-500-520

Technische Daten  
Specifications

Polzahl	2+PE/3+PE	Number of contacts
Steckverbinder Verriegelung	Zentrierschraube/central screw	Connector locking system
Anschlussart	löten, crimpen, am Kabel angespritzt/solder, crimp, moulded	Termination
Anschlussquerschnitt	0,75 mm <sup>2</sup> (AWG 20)	Wire gauge
Kabeldurchlass	-	Cable outlet
Schutzart	IP67	Degree of protection
Mechanische Lebensdauer	> 50 Steckzyklen/> 50 mating cycles	Mechanical operation
Obere Grenztemperatur	+ 85 °C	Upper temperature
Untere Grenztemperatur	- 20 °C	Lower temperature
Bemessungsspannung	250 V, 24 V	Rated voltage
Bemessungs-Stoßspannung	800 V, 4000 V	Rated impulse voltage
Verschmutzungsgrad	3	Pollution degree
Überspannungskategorie	III	Overvoltage categorie
Isolierstoffgruppe	III	Material group
Bemessungsstrom (40°C)	6 A, 4 A	Rated current (40 °C)
Durchgangswiderstand	≤ 15 mΩ	Contact resistance
Material Kontakt	CuSn (Bronze/bronze)	Material at contact
Kontaktoberfläche	Ag (Silber/silver)	Contact plating
Material Kontaktkörper	PBT	Material of contact body
Material Gehäuse	PBT	Material of housing

**Magnetventilsteckverbinder Bauform C Serie 230**  
**Solenoid valve connectors size C series 230**

**DIN**  
**DIN**

Bezeichnung  
 Description

Gerätestecker **DIN EN 175301-803**  
 Male power connector **DIN EN 175301-803**

Gerätestecker **DIN EN 175301-803**  
 Male power connector **DIN EN 175301-803**

Abbildung  
 Figure



Maßzeichnung  
 Drawing

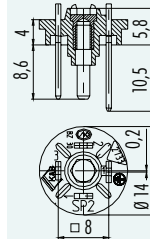
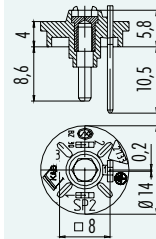

Bestell-Nr.  
 Ordering-No.

Polzahl Contacts	Bestell-Nummer Ordering-Number
2+PE	43-1901-000-03

Polzahl Contacts	Bestell-Nummer Ordering-Number
3+PE	43-1903-000-04

Technische Daten  
 Specifications

	2+PE/3+PE	Number of contacts
Steckverbinder Verriegelung	Zentrierschraube/central screw	Connector locking system
Anschlussart	löten/solder	Termination
Anschlussquerschnitt	max. 0,75 mm <sup>2</sup> (max. AWG 20)	Wire gauge
Kabeldurchlass	-	Cable outlet
Schutzart	IP65	Degree of protection
Mechanische Lebensdauer	> 50 Steckzyklen/> 50 mating cycles	Mechanical operation
Obere Grenztemperatur	+ 120 °C	Upper temperature
Untere Grenztemperatur	- 20 °C	Lower temperature
Bemessungsspannung	250 V	Rated voltage
Bemessungs-Stoßspannung	800 V	Rated impulse voltage
Verschmutzungsgrad	3	Pollution degree
Überspannungskategorie	III	Overvoltage categorie
Isolierstoffgruppe	III	Material group
Bemessungsstrom (40°C)	6 A	Rated current (40 °C)
Durchgangswiderstand	≤ 15 mΩ	Contact resistance
Material Kontakt	CuZn (Messing/brass)	Material at contact
Kontaktoberfläche	Sn (Zinn/tinn)	Contact plating
Material Kontaktkörper	PA (UL 94 HB)	Material of contact body
Material Gehäuse	-	Material of housing

## Magnetventilsteckverbinder Bauform C Serie 230 Solenoid valve connectors size C series 230

DIN  
DIN

Bezeichnung  
Description

Gerätestecker **DIN EN 175301-803**  
Male power connector **DIN EN 175301-803**

Gerätestecker **DIN EN 175301-803**  
Male power connector **DIN EN 175301-803**

Abbildung  
Figure



Maßzeichnung  
Drawing

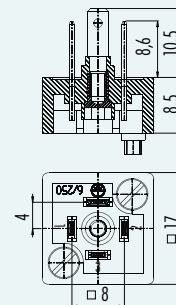
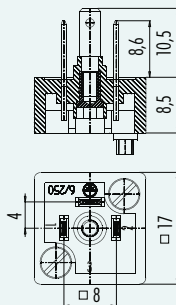

Bestell-Nr.  
Ordering-No.

Polzahl Contacts	Bestell-Nummer Ordering-Number
2+PE	43-1905-000-03

Polzahl Contacts	Bestell-Nummer Ordering-Number
3+PE	43-1907-000-04

Technische Daten  
Specifications

	2+PE/3+PE	Number of contacts
Steckverbinder Verriegelung	Zenterschraube/central screw	Connector locking system
Anschlussart	löten/solder	Termination
Anschlussquerschnitt	max. 0,75 mm <sup>2</sup> (max. AWG 20)	Wire gauge
Kabeldurchlass	-	Cable outlet
Schutzart	IP65	Degree of protection
Mechanische Lebensdauer	> 50 Steckzyklen/> 50 mating cycles	Mechanical operation
Obere Grenztemperatur	+ 100 °C	Upper temperature
Untere Grenztemperatur	- 20 °C	Lower temperature
Bemessungsspannung	250 V	Rated voltage
Bemessungs-Stoßspannung	800 V	Rated impulse voltage
Verschmutzungsgrad	3	Pollution degree
Überspannungskategorie	III	Overvoltage categorie
Isolierstoffgruppe	III	Material group
Bemessungsstrom (40°C)	6 A	Rated current (40 °C)
Durchgangswiderstand	≤ 15 mΩ	Contact resistance
Material Kontakt	CuZn (Messing/brass)	Material at contact
Kontaktoberfläche	Sn (Zinn/tinn)	Contact plating
Material Kontaktkörper	PA (UL 94 HB)	Material of contact body
Material Gehäuse	-	Material of housing



**Magnetventilsteckverbinder Bauform C Serie 235 - 230**  
**Solenoid valve connectors size C series 235 - 230**

Technische Daten  
 Specifications

Polzahl	3	4	Contacts
Querschnitt mm <sup>2</sup> 1)		-	Wire gauge mm <sup>2</sup> 1)
Material Mantel		PUR	Material jacket
Isolation Litze		PVC	Insulation wire
Litzenaufbau (mm)		42 x 0,15 mm <sup>2</sup>	Design of wire (mm)
Kabelmantel (mm)		5,9 mm	Cable jacket (mm)
Leiterwiderstand		26 Ω/Km	Resistance of wire
Temperaturbereich (Kabel bewegt)		- 5 °C / + 70 °C	Temperature range (cable in move)
Temperaturbereich (Kabel fest)		- 30 °C / + 80 °C	Temperature range (cable not in move)
Biegeradius (Kabel bewegt)		min. 60 mm	Bending radius (cable in move)
Biegeradius (Kabel fest)		min. 30 mm	Bending radius (cable not in move)
Zulassung		-	Approval

Polbilder  
 Contact arrangements

Industrie Serie 235  
 Industrial standard series 235

DIN EN 175301-803 Serie 230  
 DIN EN 175301-803 series 230

**2+PE pol**  
 2+PE contacts

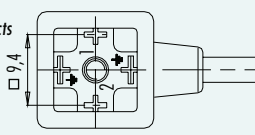

**2+PE**  
 1 schwarz 1/black 1  
 2 schwarz 2/black 2  
 ⊕ grün/gelb/green/yellow

**2+PE**  
 1 schwarz 1/black 1  
 2 schwarz 2/black 2  
 ⊕ grün/gelb/green/yellow

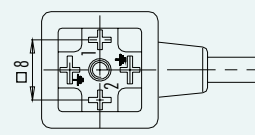

**3+PE pol**  
 3+PE contacts

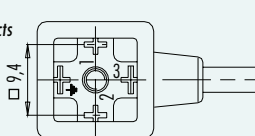

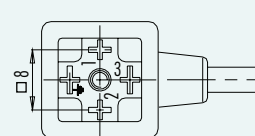

**3+PE**  
 1 schwarz 1/black 1  
 2 schwarz 2/black 2  
 3 schwarz 3/black 3  
 ⊕ grün/gelb/green/yellow

**3+PE**  
 1 schwarz 1/black 1  
 2 schwarz 2/black 2  
 3 schwarz 3/black 3  
 ⊕ grün/gelb/green/yellow

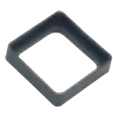
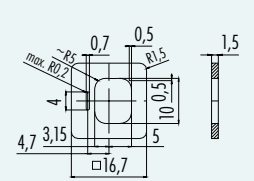
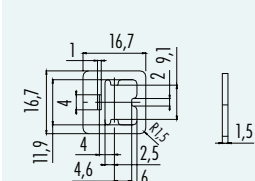
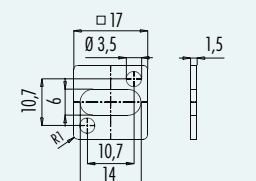
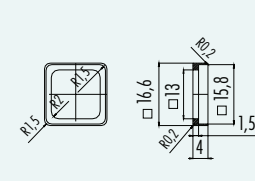

**Magnetventilsteckverbinder Bauform C** **Zubehör**  
**Solenoid valve connectors size C** **Accessories**

Bezeichnung Description	Flachdichtung Industrie Serie 235 Flat seal industrial standard series 235	Flachdichtung DIN Serie 230 Flat seal DIN series 230	Flachdichtung DIN Serie 230 Flat seal DIN series 230	Profildichtung Industrie/DIN Serie 235/230 Profiled seal industrial standard/DIN series 235/230																						
Abbildung Figure																										
Maßzeichnung Drawing																										
Bestell-Nr. Ordering-No.	<table border="1"> <tr><th>Material</th><th>Bestell-Nr. Ordering-No.</th></tr> <tr><td>NBR beige/beige</td><td>16-8110-000</td></tr> <tr><td>Silicon rot/red</td><td>16-8110-001</td></tr> </table>	Material	Bestell-Nr. Ordering-No.	NBR beige/beige	16-8110-000	Silicon rot/red	16-8110-001	<table border="1"> <tr><th>Material</th><th>Bestell-Nr. Ordering-No.</th></tr> <tr><td>NBR beige/beige</td><td>16-8107-000</td></tr> <tr><td>Silicon rot/red</td><td>16-8107-001</td></tr> <tr><td>HNBR schwarz/black</td><td>16-8107-002</td></tr> </table>	Material	Bestell-Nr. Ordering-No.	NBR beige/beige	16-8107-000	Silicon rot/red	16-8107-001	HNBR schwarz/black	16-8107-002	<table border="1"> <tr><th>Material</th><th>Bestell-Nr. Ordering-No.</th></tr> <tr><td>NBR schwarz black</td><td>16-8097-000</td></tr> </table>	Material	Bestell-Nr. Ordering-No.	NBR schwarz black	16-8097-000	<table border="1"> <tr><th>Material</th><th>Bestell-Nr. Ordering-No.</th></tr> <tr><td>NBR schwarz black</td><td>16-8106-000</td></tr> </table>	Material	Bestell-Nr. Ordering-No.	NBR schwarz black	16-8106-000
Material	Bestell-Nr. Ordering-No.																									
NBR beige/beige	16-8110-000																									
Silicon rot/red	16-8110-001																									
Material	Bestell-Nr. Ordering-No.																									
NBR beige/beige	16-8107-000																									
Silicon rot/red	16-8107-001																									
HNBR schwarz/black	16-8107-002																									
Material	Bestell-Nr. Ordering-No.																									
NBR schwarz black	16-8097-000																									
Material	Bestell-Nr. Ordering-No.																									
NBR schwarz black	16-8106-000																									

Temperaturbereich Dichtungen  
 Temperature range of seals

NBR beige/beige	-40° C – +100° C
NBR schwarz/black	-20° C – +125° C
Silicon rot/red	-60° C – +250° C

