

"Schutzvermerk nach DIN ISO 16016 beachten". "Please pay attention to copyright note DIN ISO 16016"

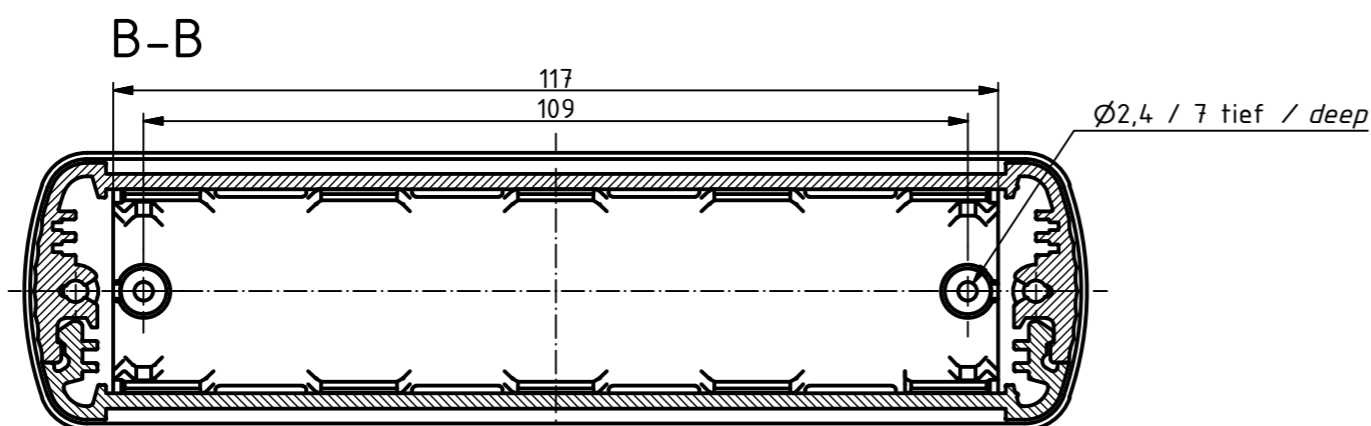
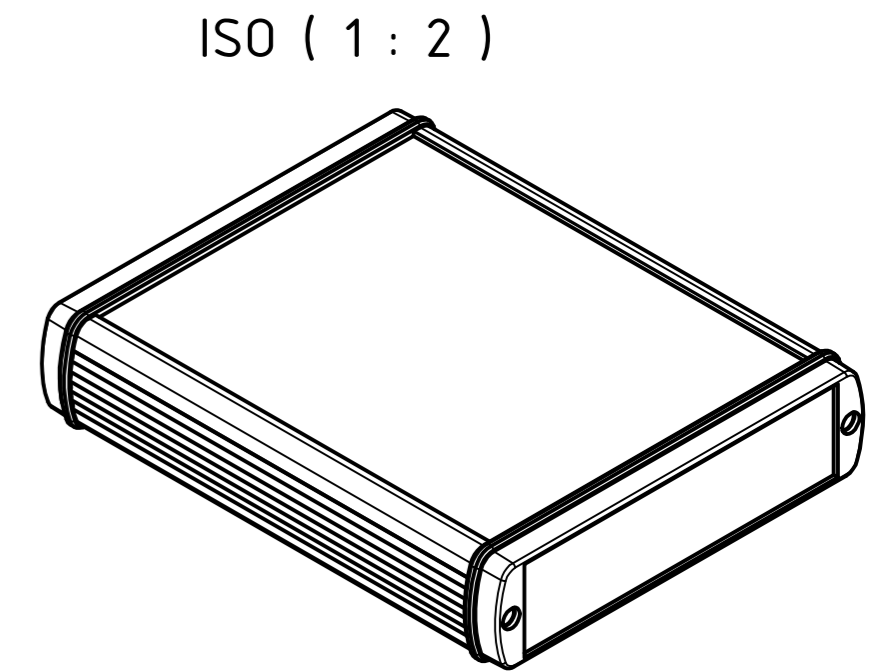
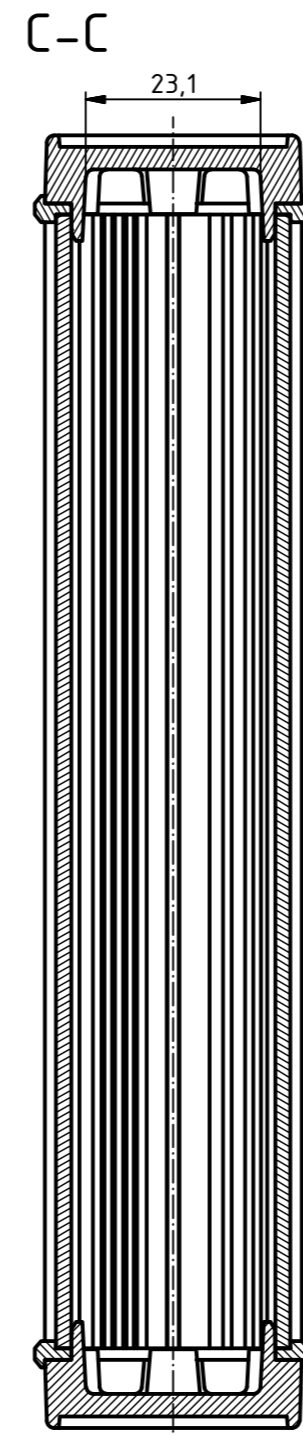
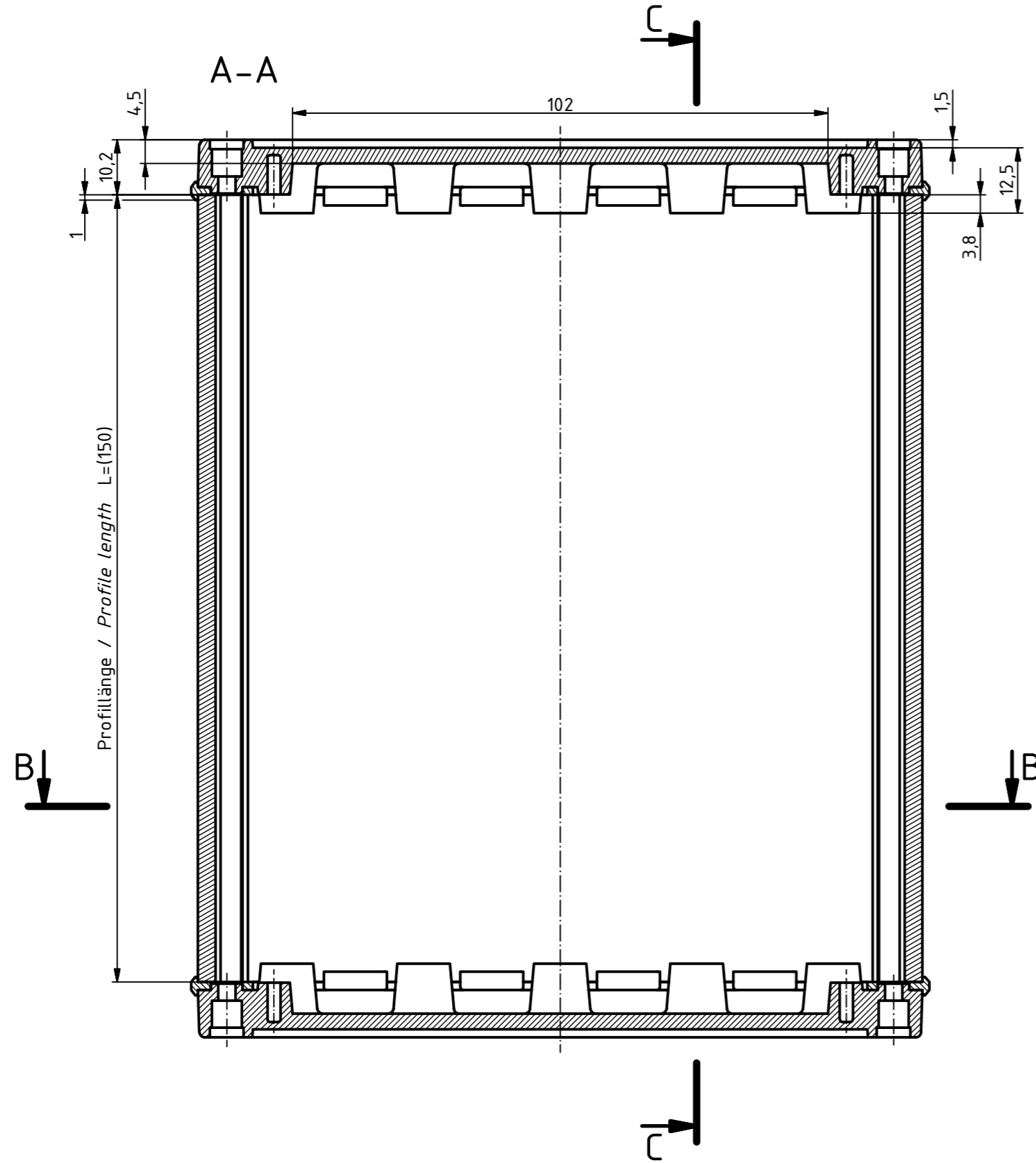
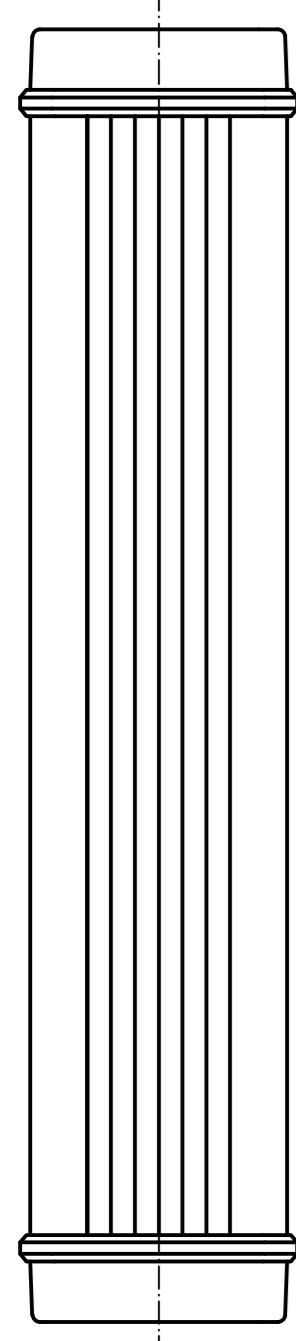
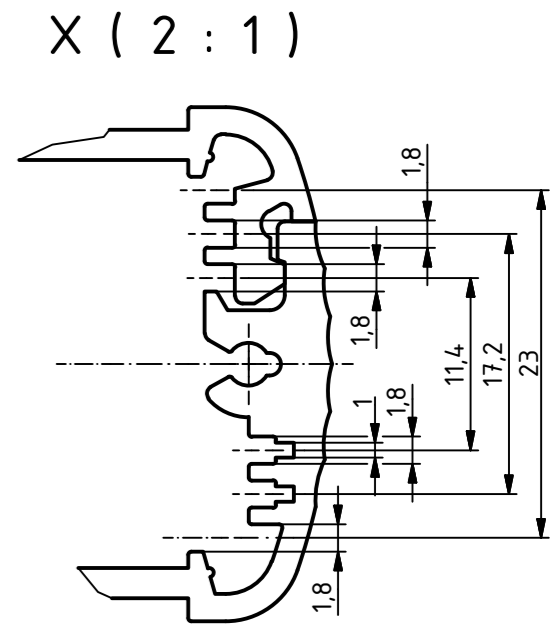
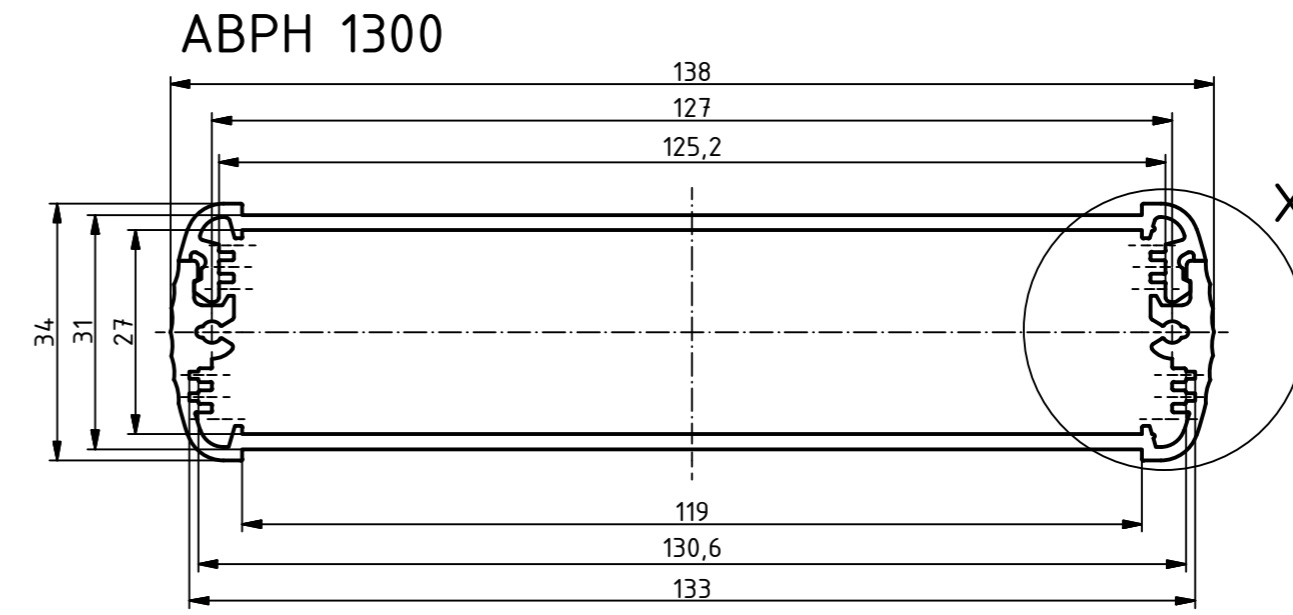
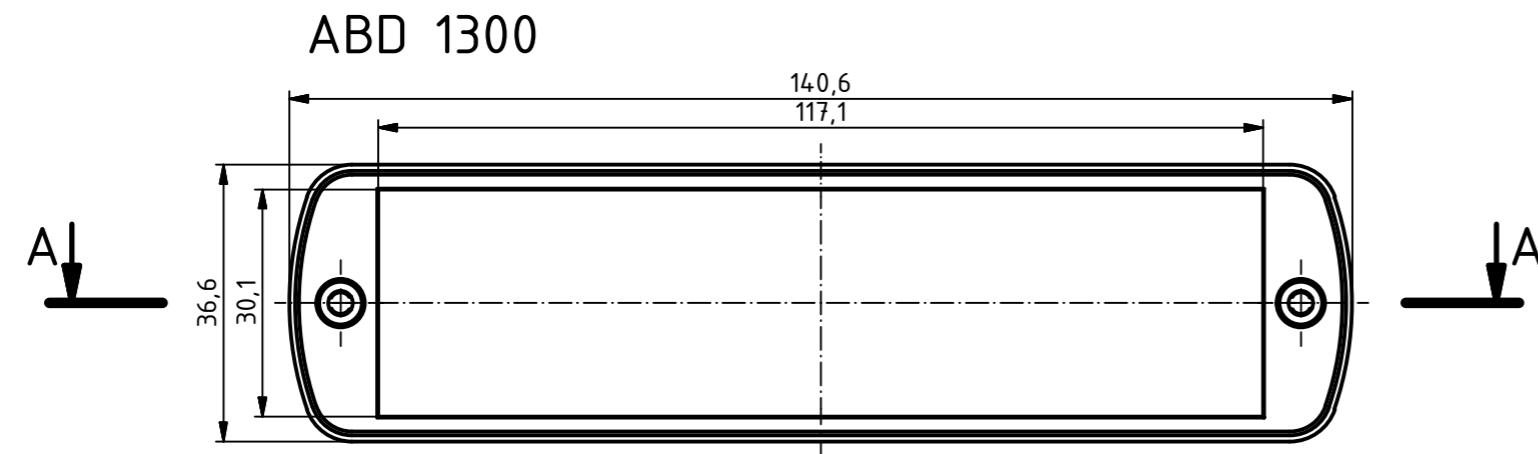

Maßstab / Scale: 1:1 (1:2, 2:1)

Zeichnungs-Nr. / Drawing-No.:

Artikel: ABPH 1300-150 + ABD Deckel
Katalogzeichnung
 Article: ABPH 1300-150 + ABD LID
 Catalogue drawing

A.Nr. /
Alt.No.:

Datum /
Date:



DISK: ABPH 1300-150 + ABD 1300.idw
 Datum / Date: 29.09.2011 JL