

"Schutzvermerk nach DIN ISO 16016 beachten" - "Please pay attention to copyright note DIN ISO 16016"

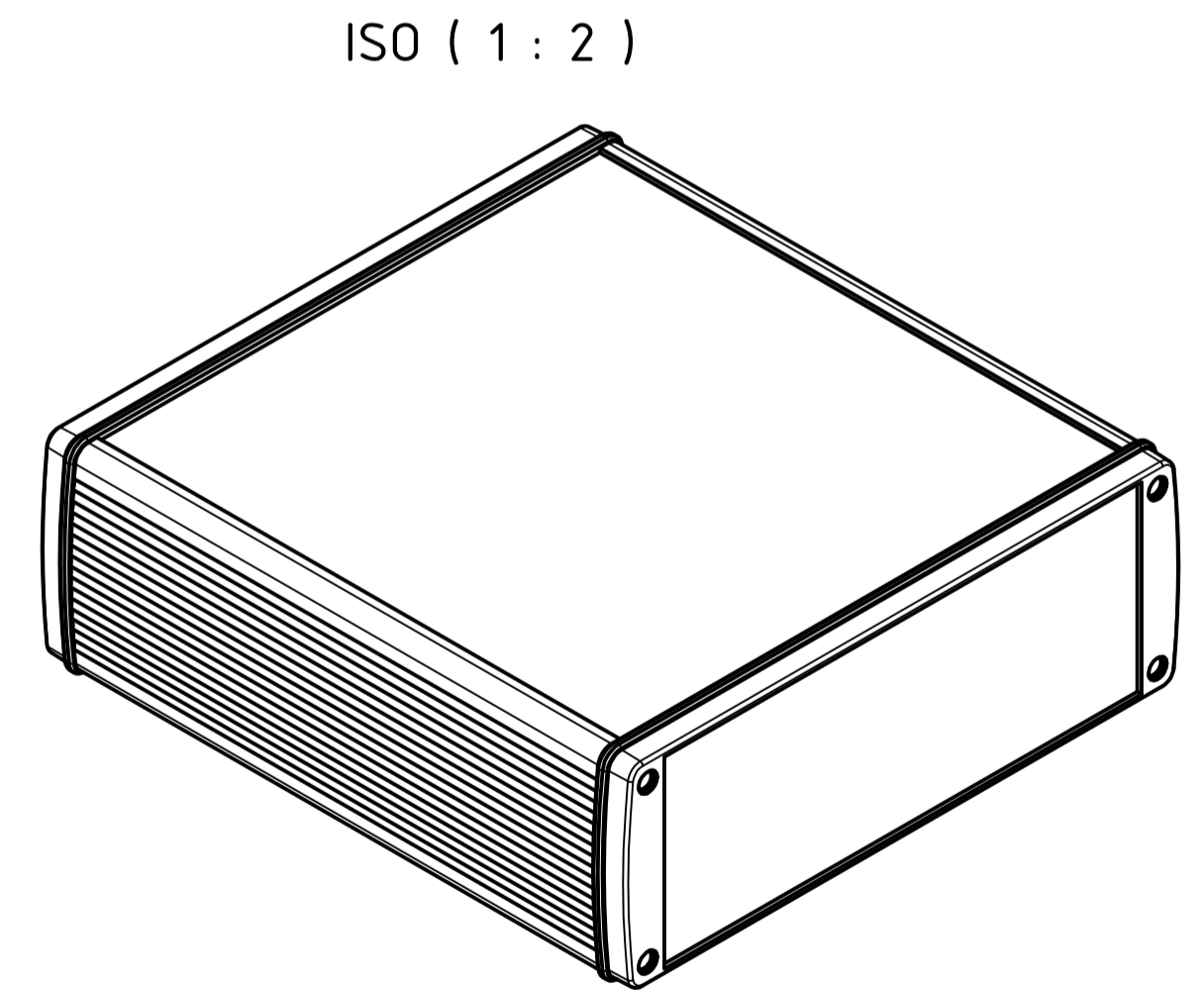
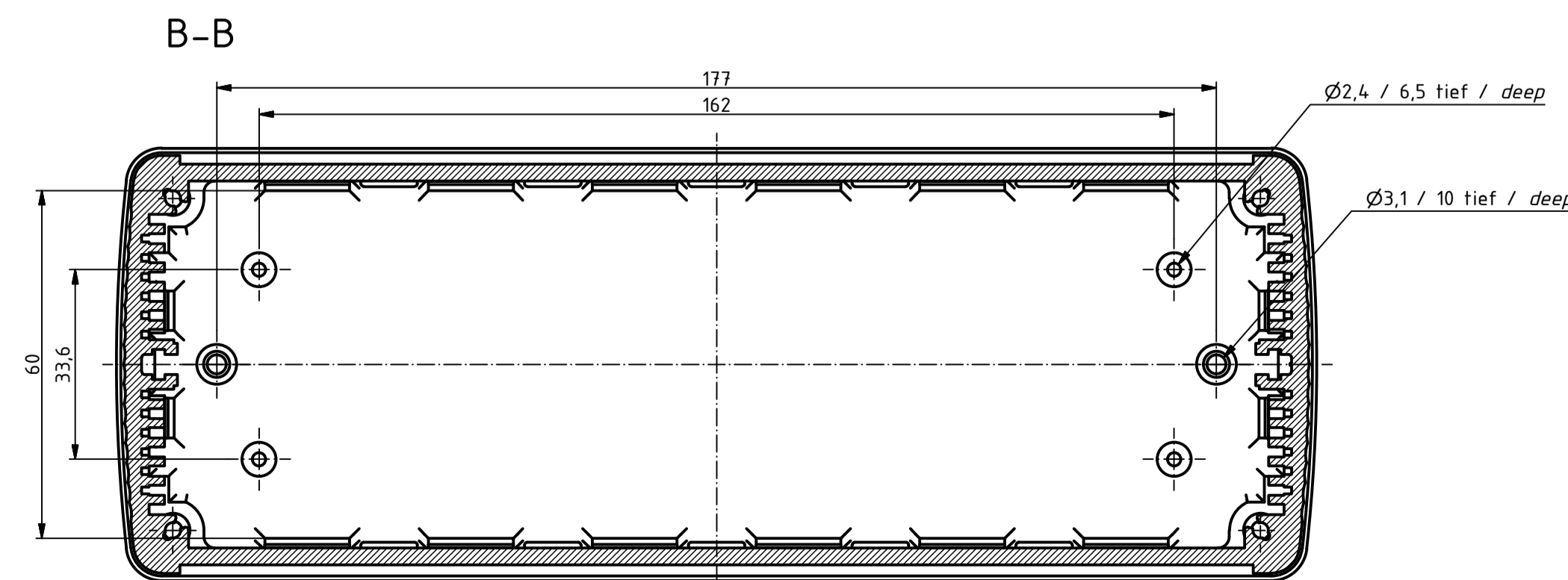
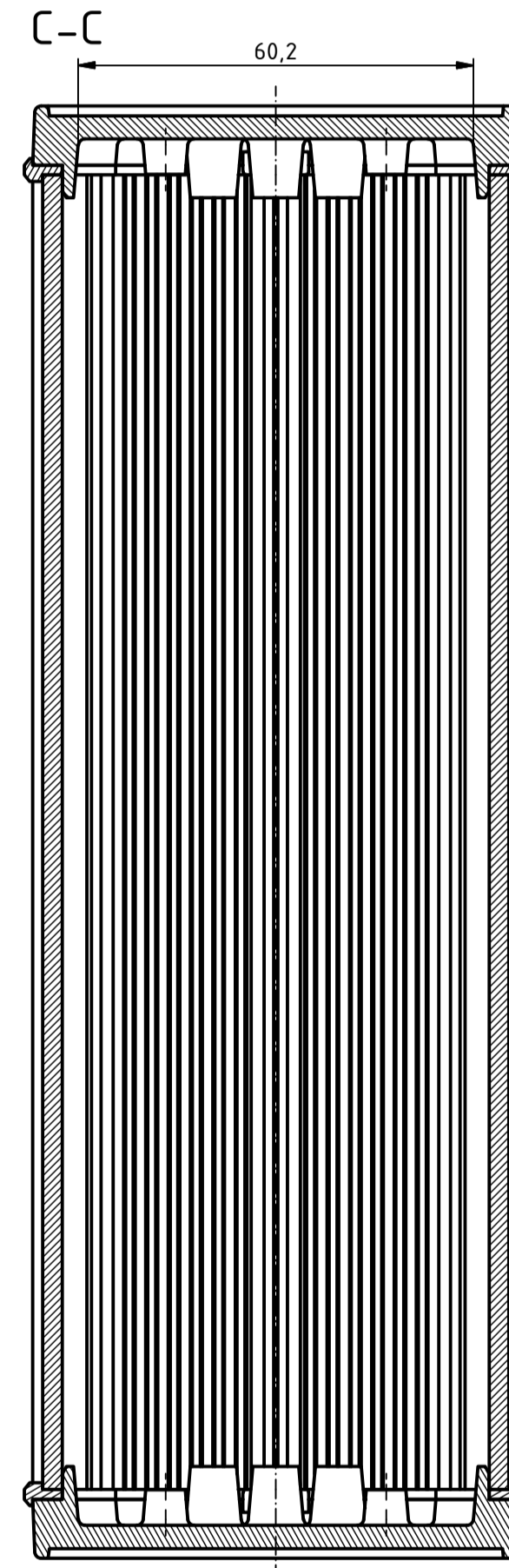
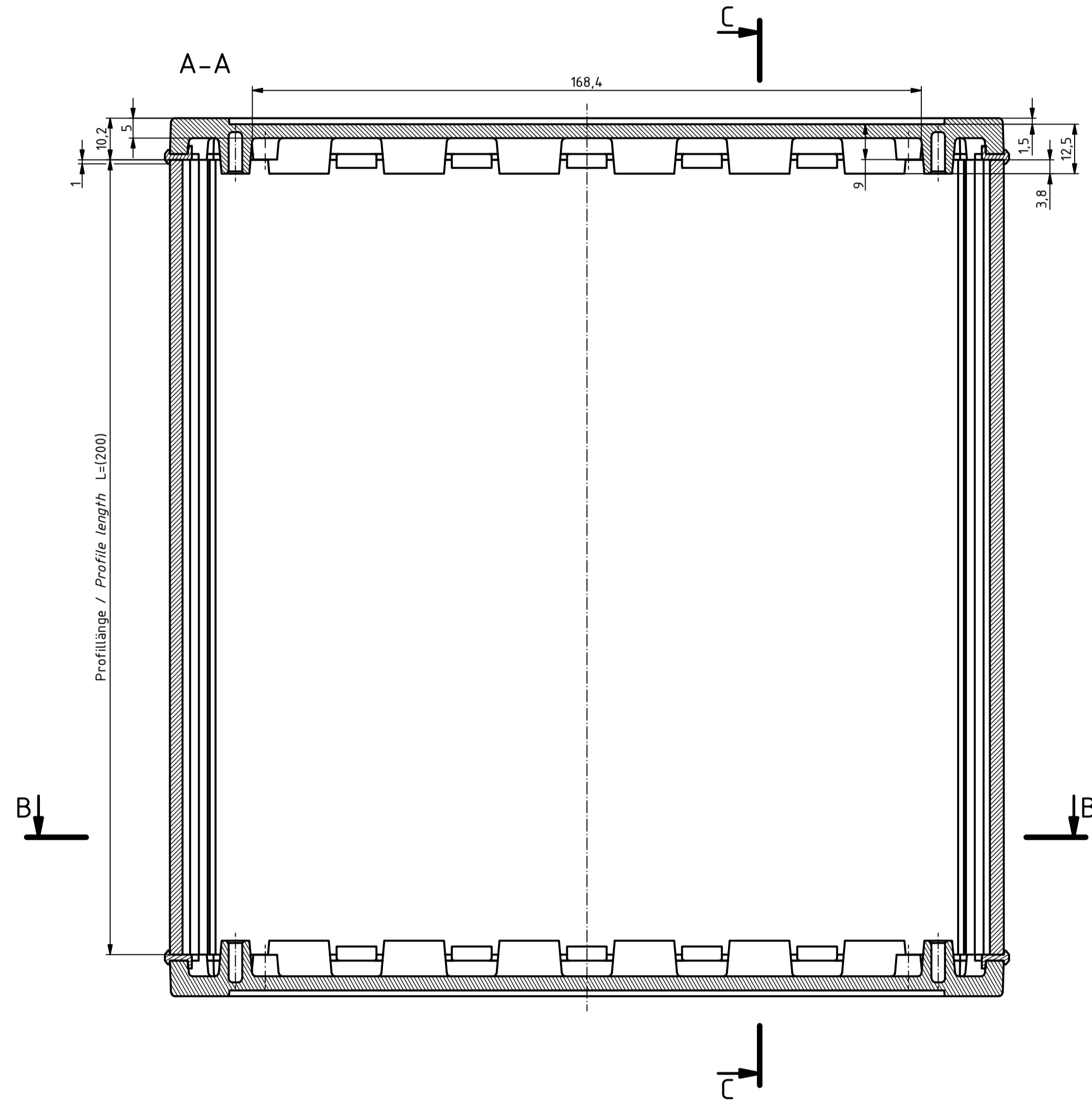
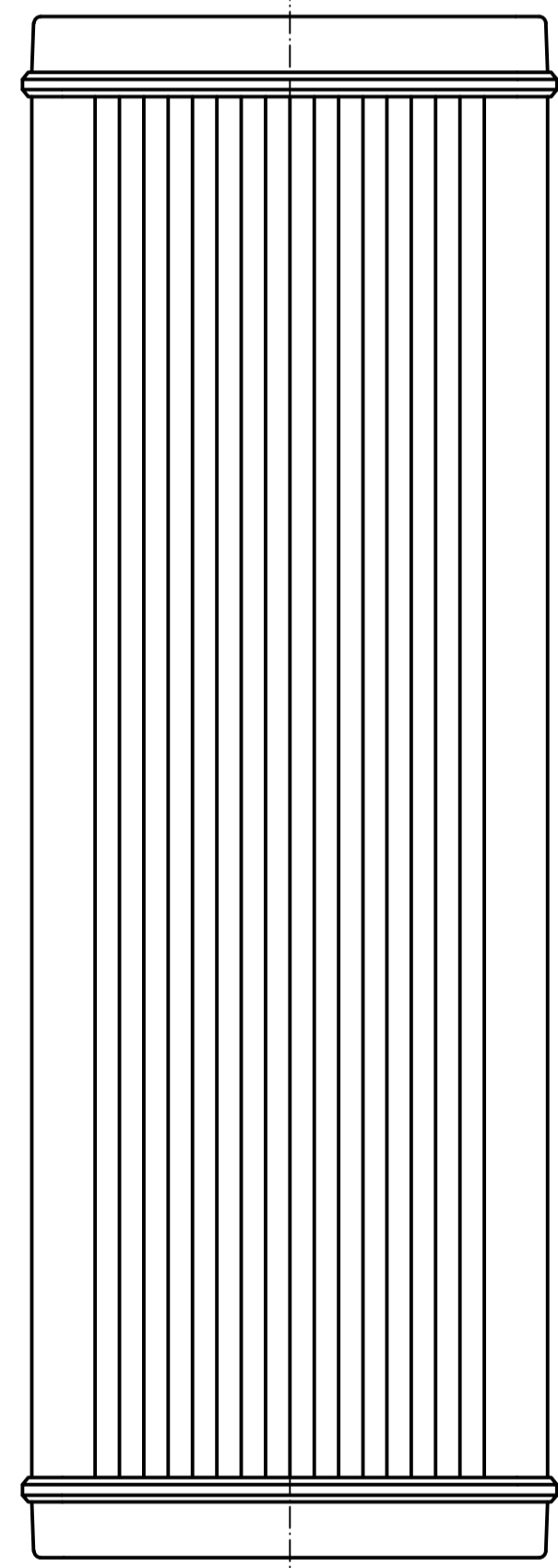
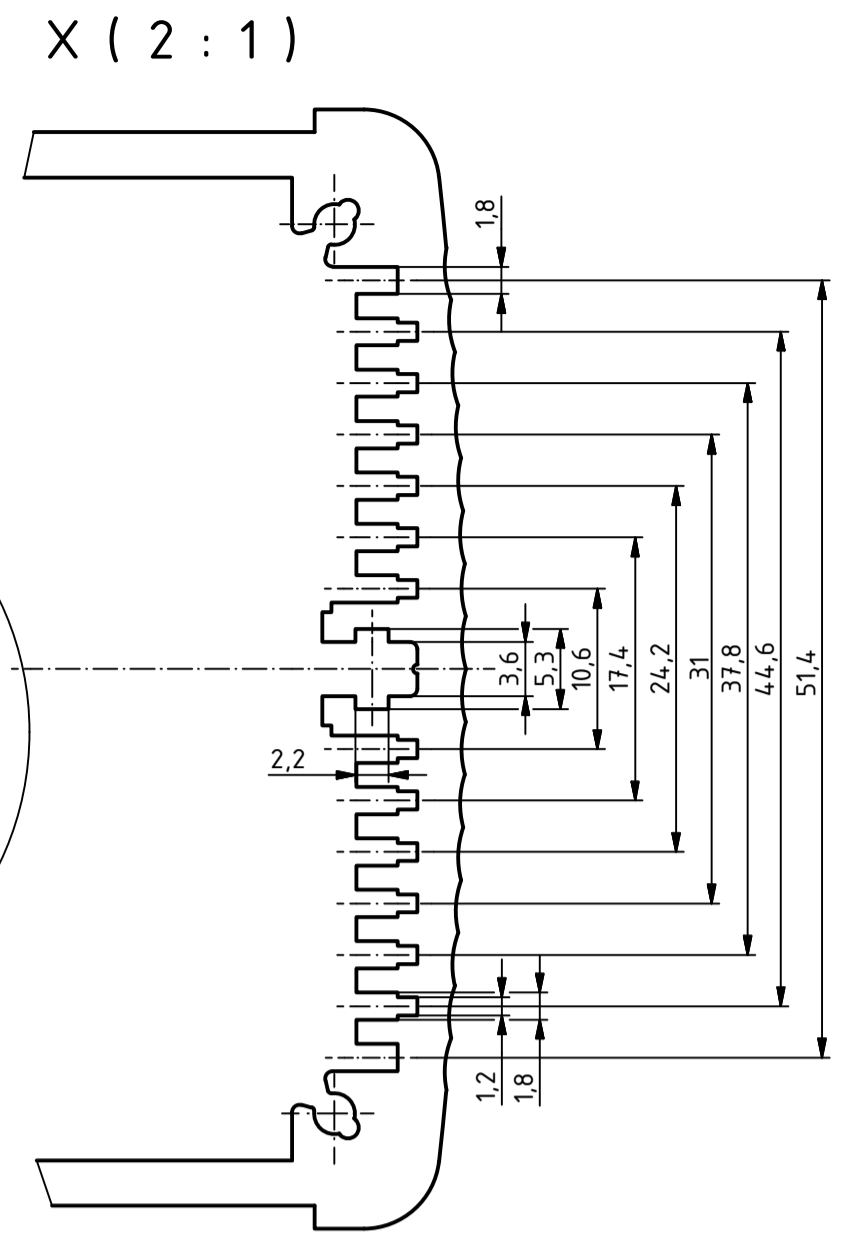
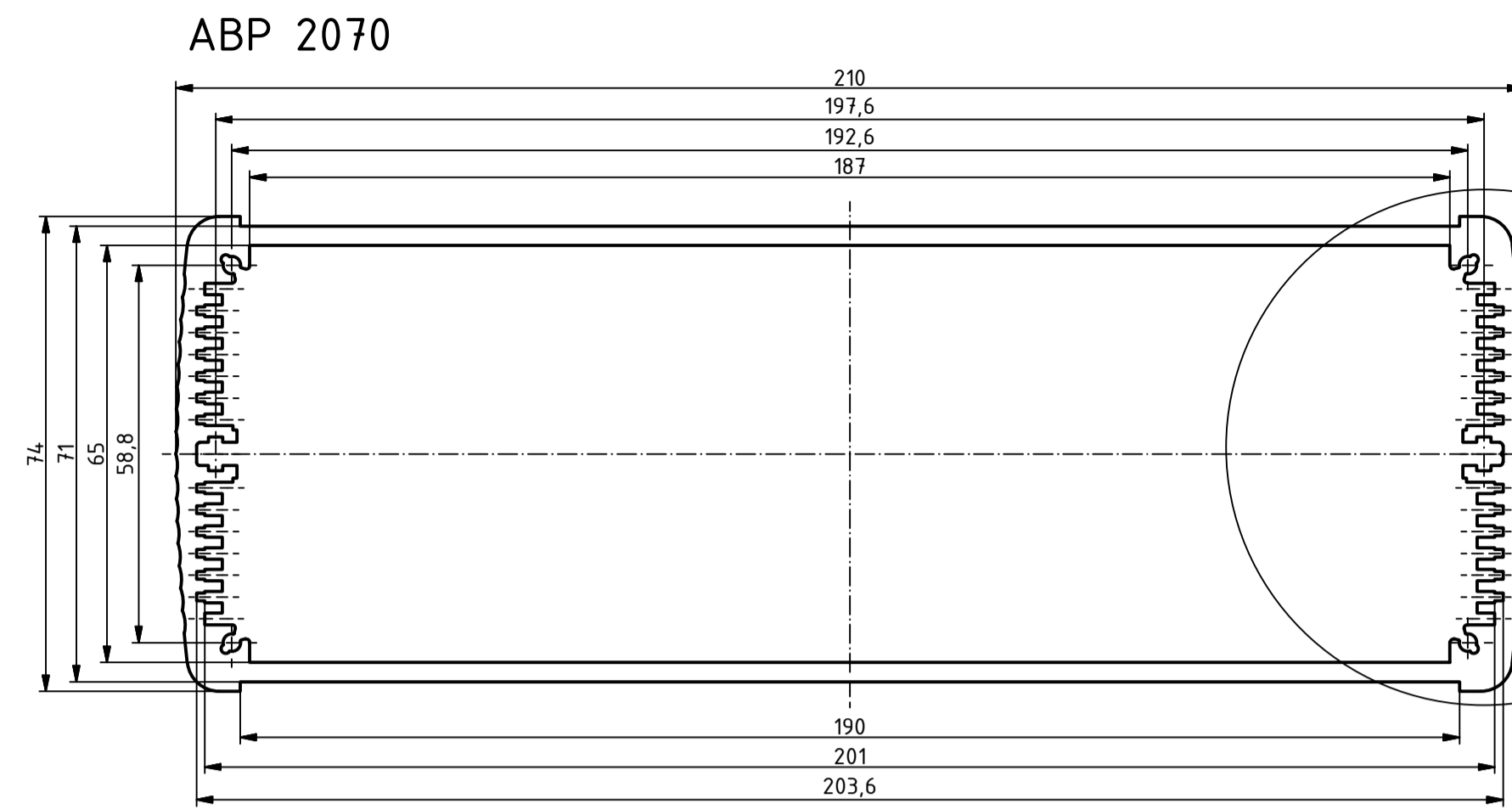
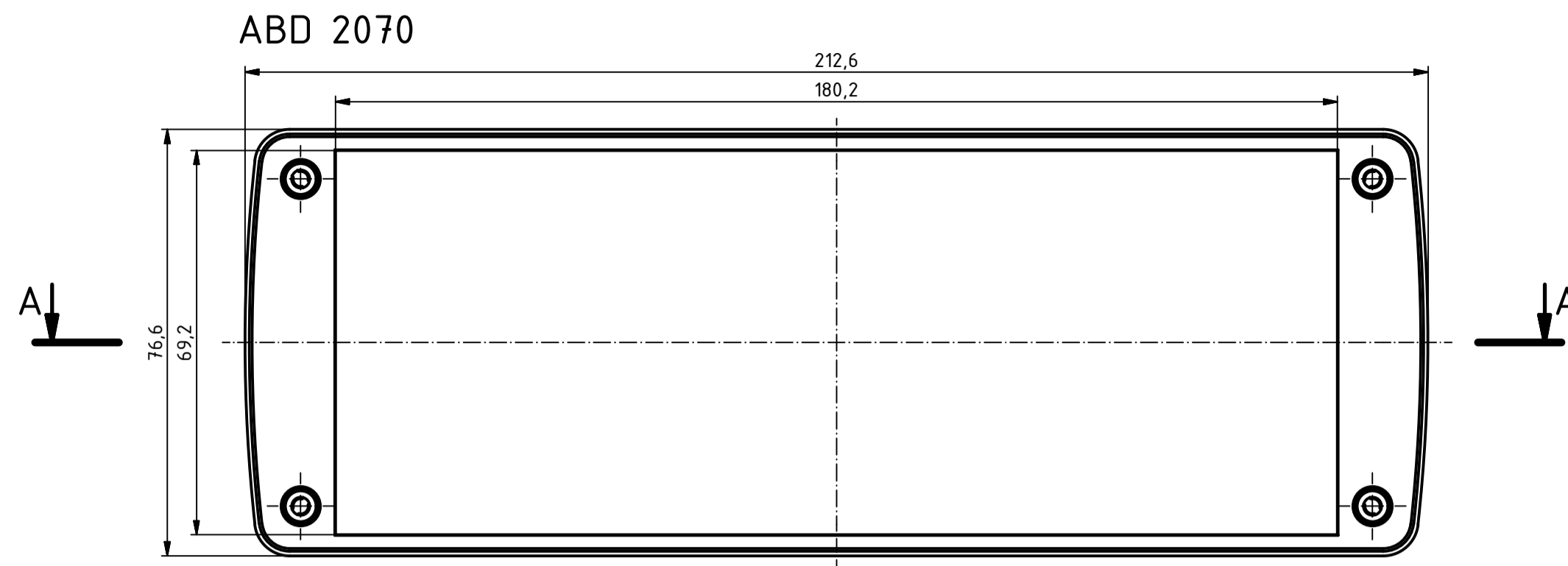

Maßstab/  
Scale:

Zeichnungs-Nr. / Drawing-No.:

Artikel: ABP 2070-200 + ABD Deckel  
Katalogzeichnung  
Article: ABP 2070-200 + ABD LID  
Catalogue drawing

A Nr. / Alt. No. Datum / Date:

DISK: ABP 2070-200 + ABD 2070.idw  
Datum/Date: 29.09.2011 JL



A Phoenix Mecano Company