

# Complete units: Mushroom heads $\varnothing$ 22

IP 66  
 Complete units consisting of:  
 - head  
 - clip and screw electrical blocks assembled  
 Plastic black bezel  
 Conform to IEC 60947-5-1

 Characteristics (p. 94)  
 Cross reference list (p. 311)

► **EN 418/ISO 13850 EMERGENCY STOP - NON ILLUMINATED**

**$\varnothing$  40 EN 418/ISO 13850 - STAY-PUT**

**Push-turn to reset**

**Cat. No.**



L22ER01D

Head position visible from the side with yellow collar  
 Compliant with the requirements of emergency stop:  
 IEC 60947-5-5 /EN 418/ISO 13850

● Red

NO + NC

**L22ER01D**

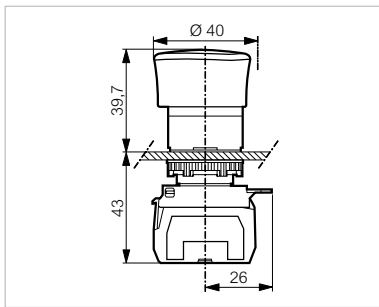

**$\varnothing$  40 EN 418/ISO 13850 - STAY-PUT**

**Push-pull to reset**

**Cat. No.**



L22DR01B

Head position visible from the side with yellow collar  
 Compliant with the requirements of emergency stop:  
 IEC 60947-5-5 /EN 418/ISO 13850

● Red

NO + NC

**L22DR01B**

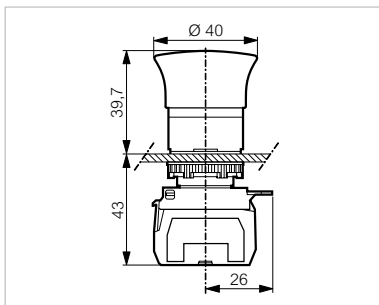

# Bohrungen und Normen

## BOHRPLÄNE

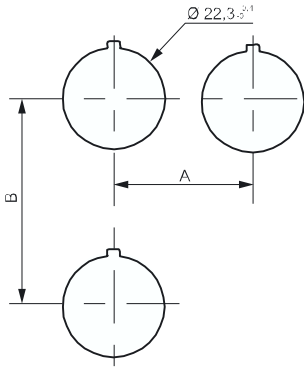

Für Geräte mit Schraubanschluss und Federzugklemme

### Abmessungen

	= 30	Mit oder ohne Einlegeschild (Standard)
	= 33	Für Silikondichtungshaube IP 67
	= 40	Mit großem Einlegeschild
<b>A</b>	> 40	Für Not-Aus Taster $\varnothing 40$
	> 45	Für Drehschalter mit Knebel lang
	= 38	Für superflachen Taster
	= 50	Bei 5-Fachadapter
	= 45	Mit oder ohne Einlegeschild (Standard)
<b>B</b>	= 54	Mit Doppeldrucktaster
	= 77	Mit Doppeldrucktaster + Einlegeschild
	= 50	Joystick

## BOHRUNG FÜR SUPERFLACHEN DRUCKTASTER

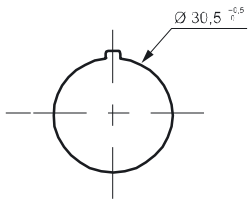

## BOHRUNG BEI VERWENDUNG DES VERDREHUNGSSCHUTZES (OPTIONAL)

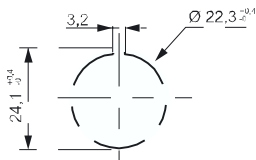

## FRONTPLATTENSTÄRKE

E = 1 bis 6 mm

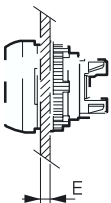

# Montageanweisung $\phi$ 22

NICHT BELEUCHTBAR

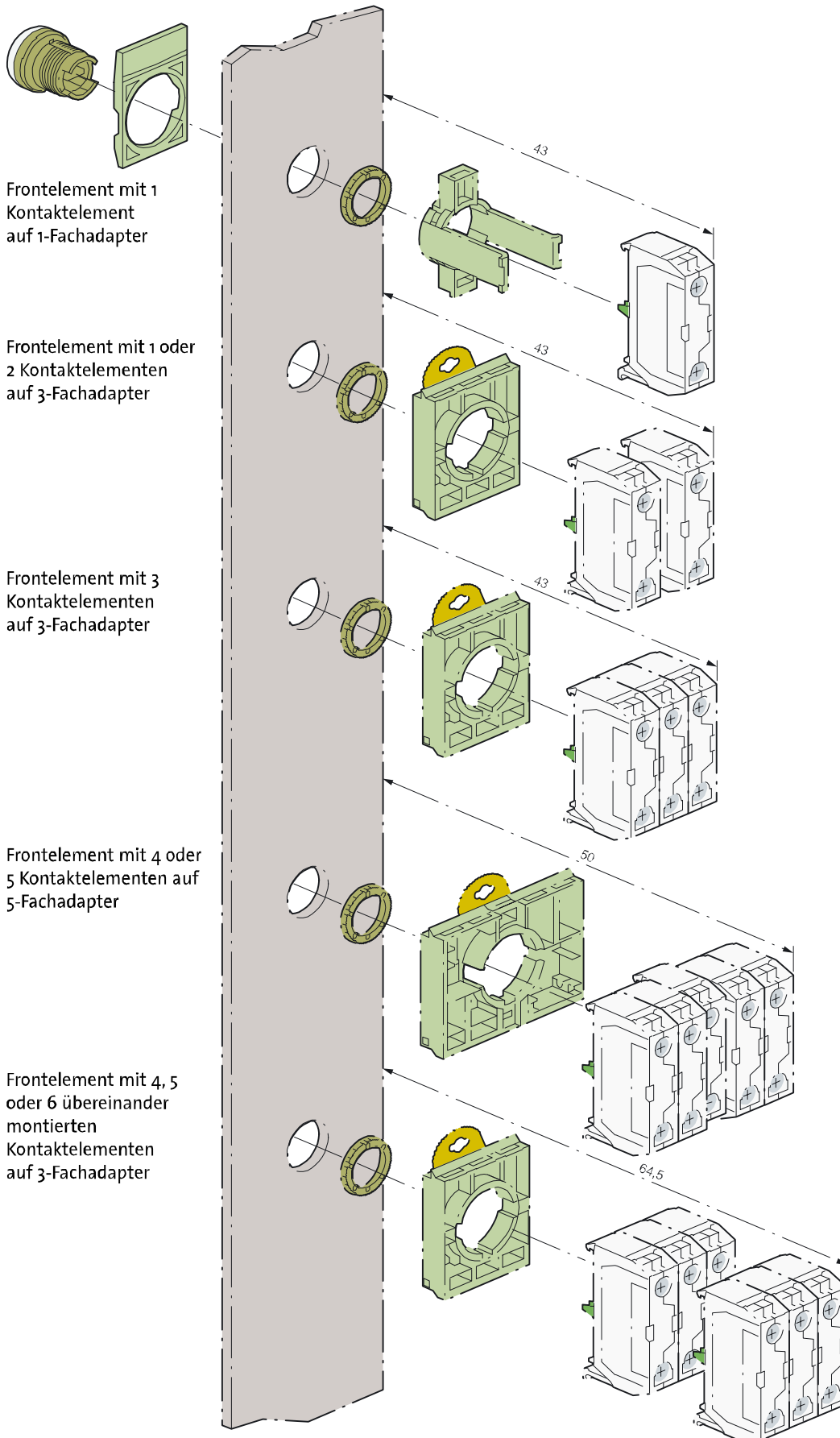

# Montageanweisung $\phi$ 22

BELEUCHTBAR

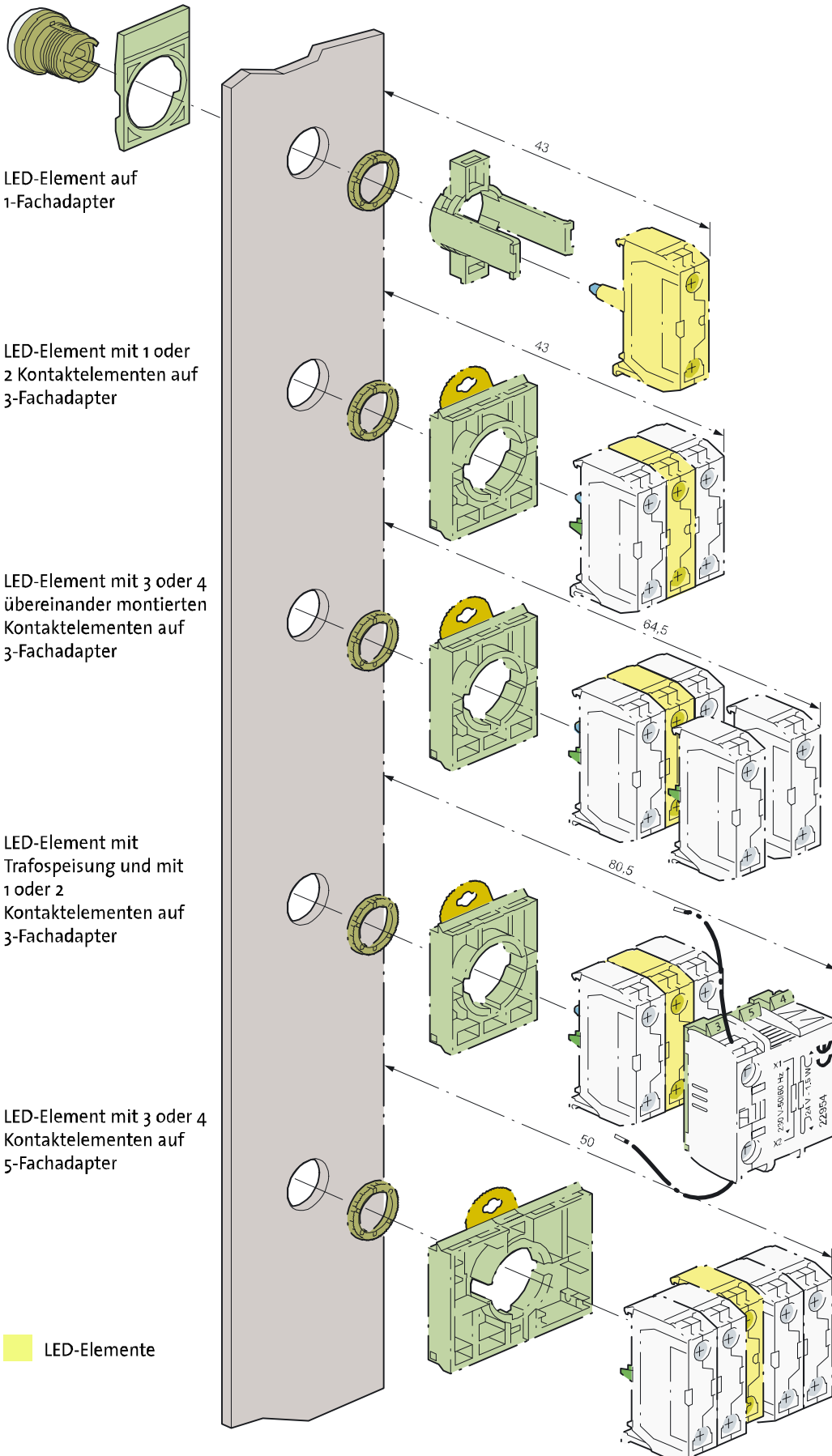

# Technische Daten

## ▶ ALLGEMEIN

Eigenschaften	Daten	Normen
▶ Lagertemperatur	- 40 °C bis + 70 °C	
▶ Temperatur bei Verwendung	- 25 °C bis + 70 °C	
▶ Klimabeständigkeit	konstant feuchtwarm zyklisch feuchtwarm Beständigkeit bei Salzwassernebel	IEC 60068-2-3 IEC 60068-2-30 IEC 60068-2-52
▶ Schutzart	IP 66 für Standardfrontelemente IP 67 für Frontelemente mit Dichtungshauben IP 66 für Gehäuse mit eingebauten Tasten IP 20 für Kontaktelemente für Kontaktelemente und Kompakt-Meldeleuchten Nema 4x, 12 und 13 für Frontelemente und Gehäuse mit eingebauten Tasten	IEC 60529    NEMA Norm
▶ Schutz gegen mechanischen Schläge	IK 05 beleuchtbare und nicht beleuchtbare Frontelemente IK 07 Leergehäuse	IEC 50102
▶ Berührungsschutz	Klasse II	IEC 60947-5-1
▶ Klemmenbezeichnung		IEC 60947-1
▶ Anzugsdrehmoment	für Muttern: 3 Nm empfohlen Klemmen: 1,2 Nm	
▶ Zulassungen	UL USA und Kanada BV Bureau Véritas OC/CB-Zertifizierung	<b>UL 508</b> Réglement Marine IEC 60947-5-1 IEC 60947-5-5 IEC 60947-5-4
▶ Rüttelfestigkeit	3 Achsen	IEC 60068-2-6

# Technische Daten

## ► KONTAKTELEMENTE

Eigenschaften für Schraubanschluss und Federzugklemme	Daten	Normen	
► Bemessungsisolationsspannung Verschmutzungsgrad 3	690 V AC 600 V AC	IEC/EN 60947-1 UL 508	
► NC-Kontakt	positive Öffnung gemäß	IEC/EN 60947-5-1	
► Bemessungsstoßspannungsfestigkeit Uimp	6 kV		
► Thermischer Dauerstrom, konventionell, im Freien	AC15: 10 A DC13: 2,5 A	IEC 60947-5-1	
► Elektrische Leistung	<p><b>Wechselstrom</b> AC15 - A 600 Ue = 120 V, Ie = 6 A Ue = 240 V, Ie = 3 A Ue = 380 V, Ie = 1,9 A Ue = 480 V, Ie = 1,5 A Ue = 500 V, Ie = 1,4 A Ue = 600 V, Ie = 1,2 A</p> <p><b>Mindestbetriebsstrom</b> - Standardelemente Ue = 24 V DC und Ie = 5 mA Ausfallrate &lt; 10<sup>-8</sup></p> <p><b>Elektrische Lebensdauer</b> 1 Mio. Zyklen für: - AC15 - B 300 Ue = 120 V, Ie = 3 A Ue = 240 V, Ie = 1,5 A</p>	<p><b>Gleichstrom</b> DC13 - Q 600 Ue = 125 V, Ie = 0,55 A Ue = 250 V, Ie = 0,27 A Ue = 400 V, Ie = 0,15 A Ue = 500 V, Ie = 0,13 A Ue = 600 V, Ie = 0,1 A</p> <p>- Elemente mit vergoldeten Kontakten Ue = 5 V DC und Ie = 1 mA Ausfallrate &lt; 10<sup>-8</sup></p> <p>- DC13 - R 300 Ue = 125 V, Ie = 0,22 A Ue = 250 V, Ie = 0,1 A</p>	IEC 60947-5-1
► Anschlussquerschnitte	Feindrähtig ohne Aderendhülse: 0,5 mm <sup>2</sup> bis 2 x 2,5 mm <sup>2</sup> Feindrähtig mit Aderendhülse: 0,5 mm <sup>2</sup> bis 2 x 1,5 mm <sup>2</sup>		
Eigenschaften Elemente mit Flachsteckanschluss	Daten	Normen	
► Bemessungsisolationsspannung Verschmutzungsgrad 3	320 V AC 300 V AC	IEC/EN60947-1 UL 508	
► NC-Kontakt	positive Öffnung gemäß	IEC/EN 60947-5-1	
► Bemessungsstoßspannungsfestigkeit Uimp	6 kV		
► Thermischer Dauerstrom, konventionell, im Freien	AC 15: 10 A DC 13: 2,5 A	IEC 60947-5-1	
► Elektrische Leistung	<p><b>Wechselstrom</b> AC15 - A 300 Ue = 120 V, Ie = 6 A Ue = 240 V, Ie = 3 A</p> <p><b>Mindestbetriebsstrom</b> Ue = 24 V DC und Ie = 5 mA Ausfallrate &lt; 10<sup>-8</sup></p> <p><b>Elektrische Lebensdauer</b> 1 Mio. Zyklen für: - AC15 - B 300 Ue = 120 V, Ie = 3 A Ue = 240 V, Ie = 1,5 A</p>	<p><b>Gleichstrom</b> DC13 - Q 300 Ue = 125 V, Ie = 0,55 A Ue = 250 V, Ie = 0,27 A</p> <p>- DC13 - R 300 Ue = 125 V, Ie = 0,22 A Ue = 250 V, Ie = 0,1 A</p>	IEC 60947-5-1
► Größe Flachsteckanschluss	6,35 mm oder 2 x 2,8 mm		

# Technische Daten

## ► KONTAKTELEMENTE

Eigenschaften Elemente mit Printanschluss	Daten	Normen	
► Bemessungsisolationsspannung Verschmutzungsgrad 3	250 V AC 250 V AC	IEC/EN60947-1 UL 508	
► NC-Kontakt	positive Öffnung gemäß	IEC/EN 60947-5-1	
► Bemessungsstoßspannungsfestigkeit Uimp	4 kV		
► Thermischer Dauerstrom, konventionell, im Freien	AC15: 5 A DC13: 1 A	IEC 60947-5-1	
► Elektrische Leistung	<b>Wechselstrom</b> AC 15 - B 300 Ue = 120 V, Ie = 3 A Ue = 240 V, Ie = 1,5 A	<b>Gleichstrom</b> DC13 - R 300 Ue = 125 V, Ie = 0,22 A Ue = 250 V, Ie = 0,1 A	IEC 60947-5-1 IEC 60947-5-4
	<b>Mindestbetriebsstrom</b> - Standardelemente Ue = 24 V DC und Ie = 5 mA Ausfallrate < 10 <sup>-8</sup>	- Elemente mit vergoldeten Kontakten Ue = 5 V DC und Ie = 1 mA Ausfallrate < 10 <sup>-8</sup>	
	<b>Elektrische Lebensdauer</b> 1 Mio. Zyklen für: - AC15 - B 300 Ue = 120 V, Ie = 3 A Ue = 240 V, Ie = 1,5 A	- DC13 - R 300 Ue = 125 V, Ie = 0,22 A Ue = 250 V, Ie = 0,1 A	
► Durchmesser Printstifte	∅ 1 mm		

## ► LED-ELEMENTE FÜR BELEUCHTBARE FRONTELEMENTE UND LED-KOMPAKT-MELDELEUCHTEN

Eigenschaften	Daten	Normen
► Bemessungsisolationsspannung Verschmutzungsgrad 3	300 V	IEC/EN 60947-5-1
>Bemessungsstoßspannungsfestigkeit Uimp	4 kV (mit Filterelement Seite 64)	IEC/EN 60947-1
► Betriebsspannung	12 bis 24 V AC/DC 48 V AC/DC (für LED-Element) 130 V AC 230 V AC	
► Frequenz	50 oder 60 Hz	
► Lebensdauer bei Speisung mit Nennspannung	Rot und gelb: 100 000 Stunden bei 25 °C Andere Farben: 50 000 Stunden bei 25 °C	
► Verbrauch der LED-Elemente	Spannung: - 24 V: 25 mA ± 20% - 48 V: 15 mA ± 5% - 130 V: 20 mA ± 10% - 230 V: 16 mA ± 30%	

# Technische Daten

## ► KOMPAKT-MELDELEUCHTEN BA9S

Eigenschaften	Daten	Normen
► Bemessungsisolationsspannung	300 V	IEC 60947-5-1
► Bemessungsstoßspannungsfestigkeit Uimp	4 kV	IEC/EN 60947-1
► Lampenleistung	2,6 W max.	

## ► FRONTELEMENTE

Eigenschaften	Daten	Normen
► Mechanische Lebensdauer (in Mio. Betätigungen)	Taster: 5 Drücken-Drücken: 0,5 Drehschalter: 0,3 Not-Aus Taster rastend EN418: 0,10 Not-Aus Taster rastend: 0,15	
► Betätigungskraft in N	Impuls + NO: 6,5 Impuls + NC: 4,5 Zusätzlicher NO-Kontakt: 4,5 Zusätzlicher NC-Kontakt: 3,0 Not-Aus Taster Zugentriegelung + NO + NC: 27 Not-Aus Taster Drehentriegelung + NO + NC: 22 Not-Aus Taster Zugentriegelung EN418 + NO + NC: 37 Not-Aus Taster Drehentriegelung EN418 + NO + NC: 60	
► Betätigungskraft in Nm	Drehschalter + NO: 0,04 Zusätzlicher NO-Kontakt: 0,03	

## ► NOT-AUS TASTER - ÜBERLISTUNGSSICHER NACH EN418

Not-Aus Taster entsprechen der IEC 60947-5-5 und DIN EN 60204. Sie sind durch einen zwangsgeführten mechanischen Bewegungsablauf überlistungssicher nach EN418. Zum Schutz gegen versehentliches Betätigen muss ein Druckpunkt überwunden werden. Die Tasten rasten in gedrückter Stellung ein und werden durch eine Rechtsdrehung entriegelt. Durch die Formgebung des Betätigungselementes ist die Schalttaste blockiergeschützt. Das heißt, ein eingeleiteter Not-Aus-Vorgang kann nicht durch verklemmende Gegenstände unterbrochen werden.



# Schaltpläne

## ARBEITSWEISE DER KONTAKTE

Für Drehschalter 3 Stellungen  
Aktivierte Elemente

Kontakt von vorn betrachtet

Nicht aktiviert    Aktiviert

Stellung des Knebels  
(von vorn betrachtet)

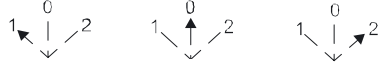

Zustand der Kontakte  
(von vorn betrachtet)

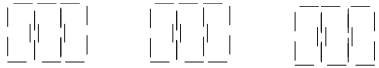

## FUNKTIONSWEISE JOYSTICK

2 Stellungen

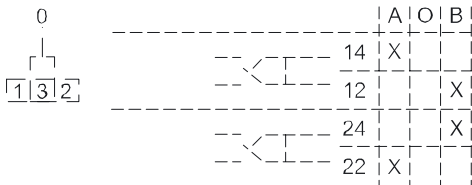

4 Stellungen

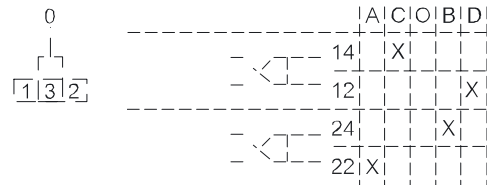

## ANSCHLUSSSCHALTPLAN LAMPENTESTELEMENT UND LED-ELEMENT

Für Speisung 24 V und 48 V AC/DC  
Test mit 1 Diode

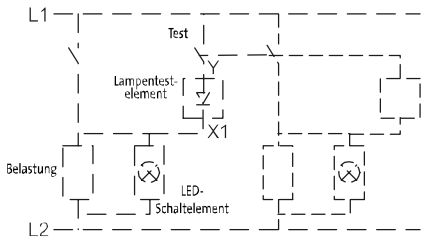

Für Speisung 24 V und 48 V AC/DC  
Test mit 2 Dioden

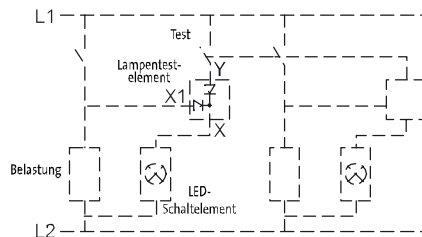

Für Speisung 130 V und 48 V AC  
Zusammenbau Test + LED (auf Anfrage)

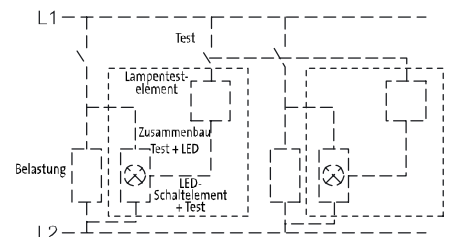

## MONTAGE AUF LEITERPLATTE

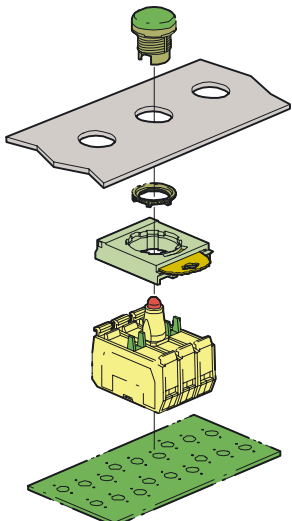

# Komplettgeräte: Not-Aus Taster $\varnothing$ 22

IP 66  
 Komplettgeräte bestehend aus: Frontelemente, Adapter und  
 Kontaktelemente mit Schraubanschluss  
 Frontring Kunststoff schwarz  
 Nach Norm EN-IEC 60947-5-1

 Technische Daten (Seite 94)  
 Vergleichstabelle (Seite 311)

## ► NOT-AUS-TASTER EN418/ISO 13850 - NICHT BELEUCHTBAR

**$\varnothing$  40 EN418/ISO 13850 - RASTEND**

**Drehentriegelung**

**Bestell-Nr.**



L22ER01D

Seitliche Zustandsanzeige mittels gelbem Ring  
 Überlastungssicher nach IEC 60947-5-5 /EN 418/ISO 13850

**Kontakt**

● Rot

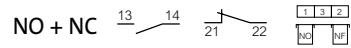

**L22ER01D**

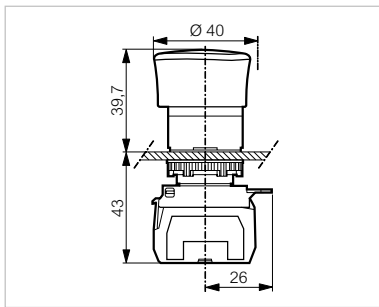

**$\varnothing$  40 EN418/ISO 13850 - RASTEND**

**Zugentriegelung**

**Bestell-Nr.**



L22DR01B

Seitliche Zustandsanzeige mittels gelbem Ring  
 Überlastungssicher nach IEC 60947-5-5 /EN 418/ISO 13850

**Kontakt**

● Rot

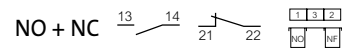

**L22DR01B**

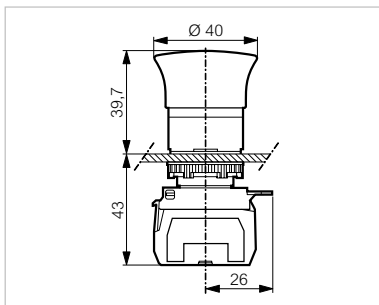

# Panel cut-out

## DRILLING

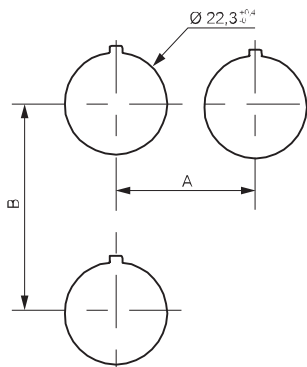

For heads equipped with electrical blocks with screw or plug-in terminals

### Minimum interval (mm)

	= 30	With or without legend (usual case)
	= 33	IP 67 (silicon shroud)
	= 40	With large legend plate
<b>A</b>	> 40	For mushroom head $\varnothing$ 40
	> 45	For selector switch with long handle
	= 38	For super-flush button
	= 50	With 5 position clip
<b>B</b>	= 45	With or without legend plate (usual case)
	= 54	With double touch
	= 77	With double touch + legend plate
	= 50	Joystick

## DRILLING FOR SUPER-FLUSH BUTTON

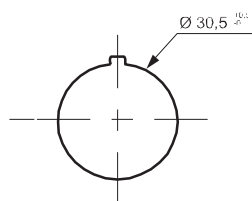

## DRILLING WHEN USING THE ANTI-ROTATION RING (OPTIONAL)

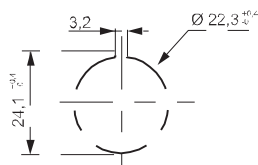

## THICKNESS OF PANEL (E)

E = 1 to 6 mm

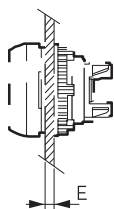

# Mounting blocks $\varnothing 22$

NON ILLUMINATED

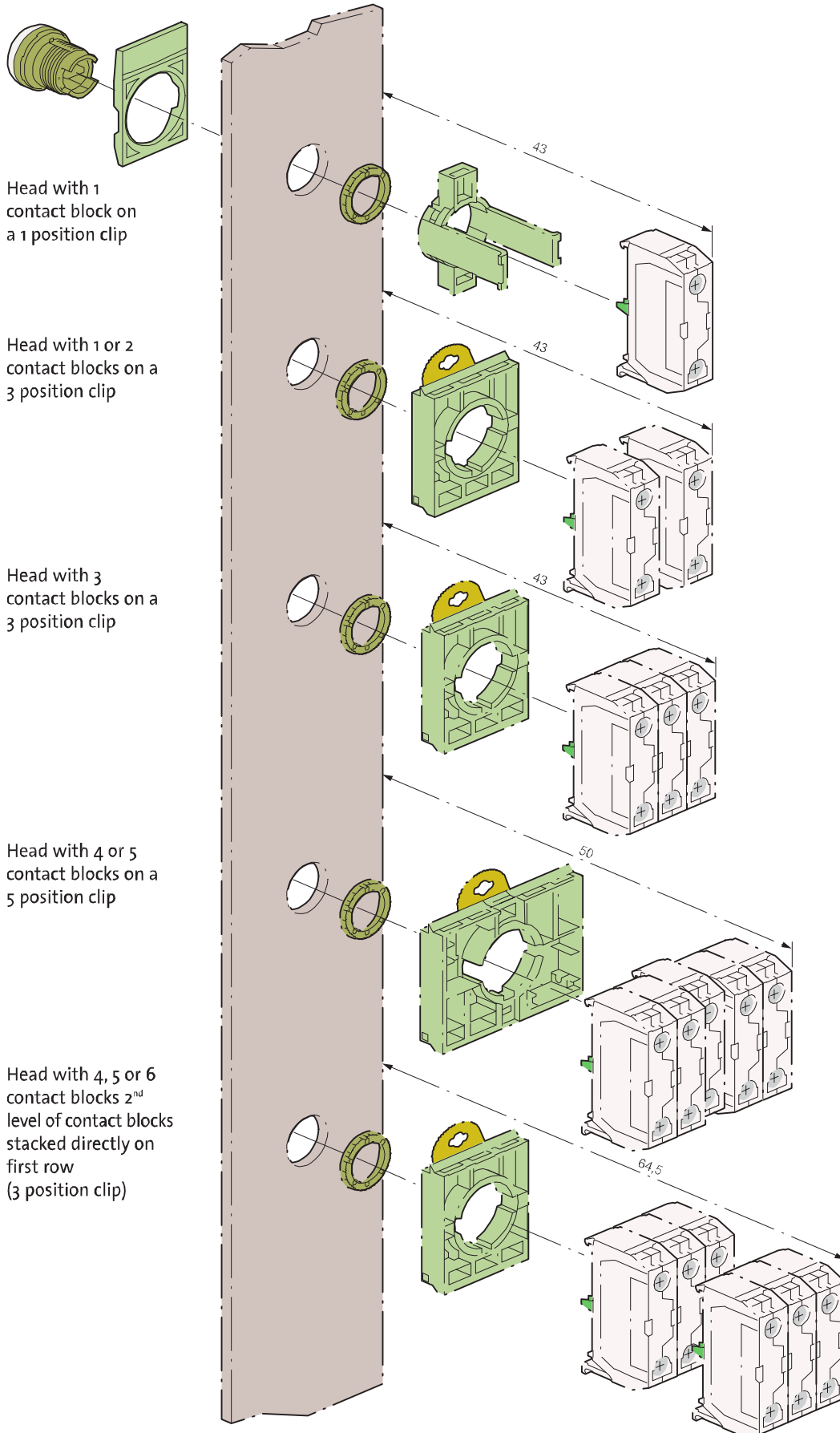

# Mounting blocks $\varnothing 22$

## ILLUMINATED

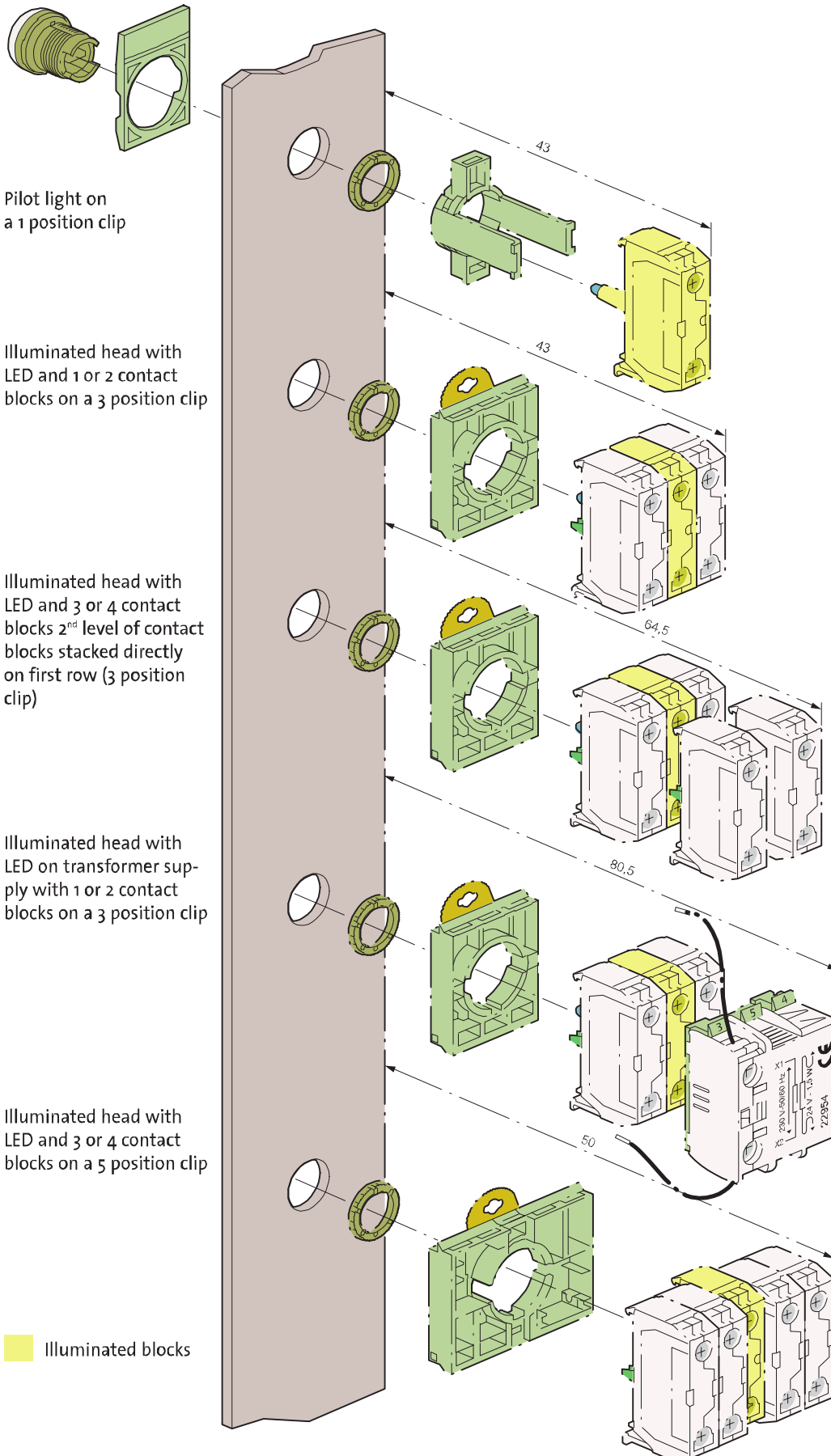

# Technical characteristics

## ▶ GENERAL

Characteristics	Data	Standards
▶ Storage temperature	- 40 °C to + 70 °C	
▶ Operating temperature	- 25 °C to + 70 °C	
▶ Climatic resistance	Constant humid heat Cyclic damp heat Resistance to sea air	IEC 60068-2-3 IEC 60068-2-30 IEC 60068-2-52
▶ Degree of protection	IP 66 for standard heads IP 67 for shrouded heads IP 66 for equipped control stations IP 20 at the rear of the panel for contact blocks and one piece pilot lights Type 1, 2, 3, 3R, 3S, 4, 4X, 12, and 13 for heads and control stations	IEC 60529     NEMA standard
▶ Protection against mechanical impacts	IK 05 illuminated and non illuminated heads IK 07 empty control station	IEC 62262
▶ Electrical insulation	Class II - heads and control station	IEC 60947-5-1
▶ Terminal marking		IEC 60947-1
▶ Tightening torques	Locking ring: recommended 3 N.m terminals: max. 1.2 N.m	
▶ Approvals	UL United states and Canada BV Bureau Véritas Certification OC/CB	UL 508, CSA 22.2 Marine rules IEC 60947-5-1 IEC 60947-5-5 IEC 60947-5-4
▶ Vibrations	withstand vibration Fc test: 2 to 25 Hz, 1.6 mm; 25-100 Hz, 4 g	IEC 60068-2-6

# Technical characteristics

## ▶ CONTACT BLOCKS

Screw and plug-in connection characteristics	Data	Standards	
▶ Rated insulation voltage	690 V AC 600 V AC	IEC/EN 60947-1 UL 508	
▶ NC contacts	Positive opening	IEC/EN 60947-5-1	
▶ Rated impulse voltage U <sub>imp</sub> Pollution degree	6kV 3		
▶ Conventional thermal current in free air conditions	AC15: 10 A DC13: 2,5 A	IEC 60947-5-1	
▶ Electrical ratings	<p><b>Alternating current</b> AC15 - A 600 U<sub>e</sub> = 120 V, I<sub>e</sub> = 6 A U<sub>e</sub> = 240 V, I<sub>e</sub> = 3 A U<sub>e</sub> = 380 V, I<sub>e</sub> = 1,9 A U<sub>e</sub> = 480 V, I<sub>e</sub> = 1,5 A U<sub>e</sub> = 500 V, I<sub>e</sub> = 1,4 A U<sub>e</sub> = 600 V, I<sub>e</sub> = 1,2 A</p> <p><b>Minimum operating current</b> - standard blocks U<sub>e</sub> = 24 V DC and I<sub>e</sub> = 5 mA Failure rate &lt; 10<sup>-8</sup></p>	<p><b>Direct current</b> DC13 - Q 600 U<sub>e</sub> = 125 V, I<sub>e</sub> = 0,55 A U<sub>e</sub> = 250 V, I<sub>e</sub> = 0,27 A U<sub>e</sub> = 400 V, I<sub>e</sub> = 0,15 A U<sub>e</sub> = 500 V, I<sub>e</sub> = 0,13 A U<sub>e</sub> = 600 V, I<sub>e</sub> = 0,1 A</p> <p>- golden contacts U<sub>e</sub> = 5 V DC and I<sub>e</sub> = 1 mA Failure rate &lt; 10<sup>-8</sup></p>	IEC 60947-5-1
▶ Electrical operating life	<p><b>1 million cycles for:</b> - AC15 - B 300 U<sub>e</sub> = 120 V, I<sub>e</sub> = 3 A U<sub>e</sub> = 240 V, I<sub>e</sub> = 1,5 A</p>	<p>- DC13 - R 300 U<sub>e</sub> = 125 V, I<sub>e</sub> = 0,22 A U<sub>e</sub> = 250 V, I<sub>e</sub> = 0,1 A</p>	
▶ Applicable wire sizes	Rigid or flexible wire without ferrule: 0,5 mm <sup>2</sup> to 2 x 2,5 mm <sup>2</sup> Rigid or flexible wire with ferrule: 0,5 mm <sup>2</sup> to 2 x 1,5 mm <sup>2</sup>		
Faston connection	Data	Standards	
▶ Rated insulation voltage	320 V AC 300 V AC	IEC/EN60947-1 UL 508	
▶ NC contacts	Positive opening	IEC/EN 60947-5-1	
▶ Rated impulse withstanding voltage U <sub>imp</sub> Pollution degree	6 kV 3		
▶ Conventional thermal current in free air conditions	AC 15: 10 A DC 13: 2,5 A	IEC 60947-5-1	
▶ Electrical ratings	<p><b>Alternating current</b> AC15 - A 300 U<sub>e</sub> = 120 V, I<sub>e</sub> = 6 A U<sub>e</sub> = 240 V, I<sub>e</sub> = 3 A</p> <p><b>Minimum current of use</b> U<sub>e</sub> = 24 V DC and I<sub>e</sub> = 5 mA Failure rate &lt; 10<sup>-8</sup></p>	<p><b>Direct current</b> DC13 - Q 300 U<sub>e</sub> = 125 V, I<sub>e</sub> = 0,55 A U<sub>e</sub> = 250 V, I<sub>e</sub> = 0,27 A</p> <p>- DC13 - R 300 U<sub>e</sub> = 125 V, I<sub>e</sub> = 0,22 A U<sub>e</sub> = 250 V, I<sub>e</sub> = 0,1 A</p>	IEC 60947-5-1
▶ Electrical operating life	<p><b>1 million cycles for:</b> - AC15 - B 300 U<sub>e</sub> = 120 V, I<sub>e</sub> = 3 A U<sub>e</sub> = 240 V, I<sub>e</sub> = 1,5 A</p>	<p>- DC13 - R 300 U<sub>e</sub> = 125 V, I<sub>e</sub> = 0,22 A U<sub>e</sub> = 250 V, I<sub>e</sub> = 0,1 A</p>	
▶ Faston size	6,35 mm or 2 x 2,8 mm		

# Technical characteristics

## ▶ CONTACT BLOCKS

Pin-style connection (for PCB)	Data	Standards	
▶ Rated insulation voltage	250 V AC 250 V AC	IEC/EN60947-1 UL 508	
▶ NC contacts	Positive opening	IEC/EN 60947-5-1	
▶ Rated impulse withstanding voltage Uimp Pollution degree	4 kV 3		
▶ Conventional thermal current in free air conditions	AC 15: 5 A DC 13: 1 A	IEC 60947-5-1	
▶ Electrical ratings	<b>Alternating current</b> AC 15 - B 300 Ue = 120 V, Ie = 3 A Ue = 240 V, Ie = 1,5 A	<b>Direct current</b> DC13 - R 300 Ue = 125 V, Ie = 0,22 A Ue = 250 V, Ie = 0,1 A	IEC 60947-5-1 IEC 60947-5-4
	<b>Minimum current of use</b> - standard blocks Ue = 24 V DC and Ie = 5 mA Failure rate < 10 <sup>-8</sup>	- golden contacts Ue = 5 V DC and Ie = 1 mA Failure rate < 10 <sup>-8</sup>	
▶ Electrical operating life	<b>1 million cycles for:</b> - AC15 - B 300 Ue = 120 V, Ie = 3 A Ue = 240 V, Ie = 1,5 A	- DC13 - R 300 Ue = 125 V, Ie = 0,22 A Ue = 250 V, Ie = 0,1 A	
▶ Pin diameter	∅ 1 mm		

## ▶ LED BLOCKS FOR ILLUMINATED HEADS AND ONE PIECE LED PILOT LIGHTS

Characteristics	Data	Standards
▶ Rated insulation voltage	300 V	IEC/EN 60947-5-1
▶ Rated impulse voltage Uimp Pollution degree	4 kV (with filter block see p. 64) 3	IEC/EN 60947-5-1
▶ Operating voltage	12 to 24 V AC/DC 48 V AC/DC (for LED block) 130 V AC 230 V AC	
▶ Frequency	50 or 60 Hz	
▶ Lifetime at rated supply voltage	Red and yellow: 100 000 hours at 25 °C Other colours: 50 000 hours at 25 °C	
▶ Consumption of LED blocks	Voltage: - 24 V: 25 mA ± 20% - 48 V: 15 mA ± 5% - 130 V: 20 mA ± 10% - 230 V: 16 mA ± 30%	



# Technical characteristics

## ▶ ONE PIECE PILOT LIGHT BA9S

Characteristics	Data	Standards
▶ Rated insulation voltage	400 V	IEC 60947-5-1
▶ Rated impulse withstand voltage Uimp	4 kV	IEC/EN 60947-1
▶ Bulb rating	400 V max. - 2,6 W max. 240 V max. - 2,6 W max.	IEC 60947-5-1 UL 508

## ▶ HEADS

Characteristics	Data	Standards
▶ Mechanical endurance (in million cycles)	Spring return: 5 Push-push: 0,5 Selector switches: 0,3 Mushroom head maintained function EN 418: 0,10 Mushroom head maintained function: 0,15	
▶ Activation force in N	Spring return + NO: 6,5 Spring return + NC: 4,5 Additional NO contact: 4,5 Additional NC contact: 3,0 Push-pull mushroom head + NO + NC: 27 Push-turn mushroom head + NO + NC: 22 Push-pull mushroom head EN 418 + NO + NC: 37 Push-turn mushroom head EN 418 + NO + NC: 60	
▶ Activation force in Nm	Selector switch + NO: 0,04 Additional NO contact: 0,03	

## ▶ EMERGENCY STOP ACTUATORS - EN 418:

For equipment subject to Machine Security Directive CE 98/37 and EN60204 standard.

BACO emergency stop switches EN418 and contact blocks meet the requirements of the European Machine Directive EN 418 and EN60947-5-5 specification.

Our E-stops provide the "fool-proof" or "tease-proof" emergency stop switch feature - described below, that latches in the emergency stop command and then switches the contact state to open the circuit and shut down the equipment.

"After the emergency stop command has been generated during actuation of the emergency stop device, the command shall be maintained by engagement (latching-in) of the actuating means. The emergency stop command shall be maintained until the emergency stop device is reset (disengaged). It shall not be possible for the emergency stop device to engage without generating the stop command."

Simply stated, this directive indicates that the latching mechanism of the switch is activated when the actuator is pushed to a certain point. The switch will continue to remain in this latched position until manually reset by twisting to release.

# Diagrams

## MECHANICAL OPERATION

For 3 position selector switches

Handle position  
(front side view)

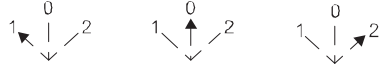

Contacts block actuation  
(back view)



Back side view

Non operated block

Operated block



## MECHANICAL OPERATION

For Joysticks

2 positions

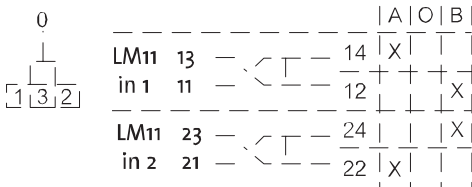

4 positions

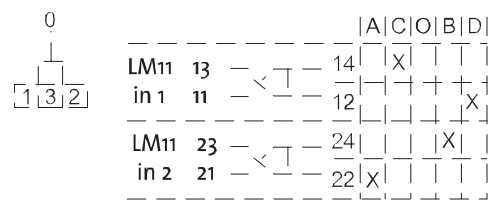

## PUSH-TO-TEST LED PILOT LIGHT DIAGRAMS

Lamp-testing module with 1 diode (33ET) for direct supply 24 V and 48 V

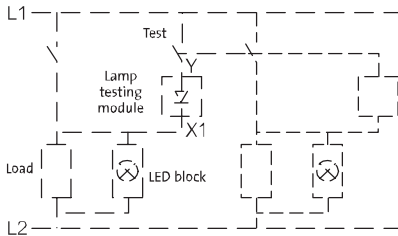

Lamp-testing module with 2 diodes (33ETT) for direct supply 24 V and 48 V

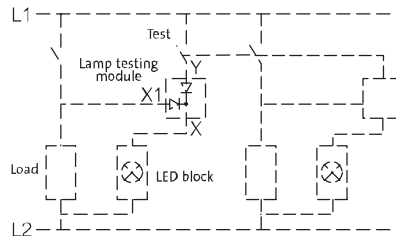

Lamp-testing assembly for direct supply 130 V and 240 V (Consult us - see page 79)

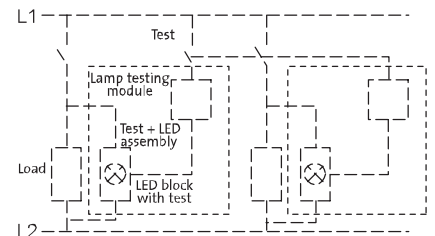

## PRINTED CIRCUIT BOARD MOUNTING

