

Control stations Ø 22

IP 66
 Base mounted contact-screw terminals
 Conform to IEC 60947-5-1
 Marking on control station
 Frames and legend plates (p. 66)
 Special engraving and mounting (form p. 90)

 Characteristics (p. 94)
 Cross reference list (p. 311)

► CONTROL STATIONS WITH 1 BUTTON (CONTINUED)

MUSHROOM HEAD Ø 40 EN 418/ISO 13850 - STAY-PUT Push-pull to reset





Cat. No.

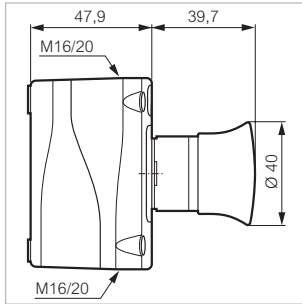

LBX15101

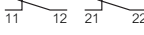

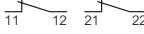
Compliant with the requirements of emergency stop: IEC 60947-5-5 / EN 418/ISO 13850

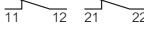
● Red	NC		ARRÊT D'URGENCE	LBX15101
● Red	2 NC		ARRÊT D'URGENCE	LBX15102
● Red	NC		NOT AUS	LBX15201
● Red	2 NC		NOT AUS	LBX15202
● Red	NC		EMERGENCY STOP	LBX15301
● Red	2 NC		EMERGENCY STOP	LBX15302

Contact blocks fixed behind cover (form p. 90)





MUSHROOM HEAD Ø 40 EN 418/ISO 13850 - STAY-PUT Key to reset

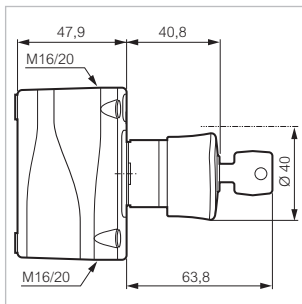

LBX11302

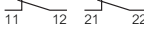

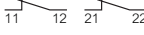
Compliant with the requirements of emergency stop: IEC 60947-5-5 / EN 418/ISO 13850
 Supplied with 2 keys profile n° 455

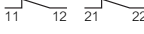
● Red	NC		ARRÊT D'URGENCE	LBX11101
● Red	2 NC		ARRÊT D'URGENCE	LBX11102
● Red	NC		NOT AUS	LBX11201
● Red	2 NC		NOT AUS	LBX11202
● Red	NC		EMERGENCY STOP	LBX11301
● Red	2 NC		EMERGENCY STOP	LBX11302

Contact blocks fixed behind cover (form p. 90)





MUSHROOM HEAD Ø 54 EN 418/ISO 13850 - STAY-PUT Push-pull to reset with flag indicator

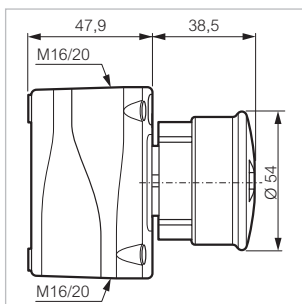

LBX14201

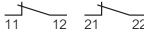

Compliant with the requirements of emergency stop: IEC 60947-5-5 / EN 418/ISO 13850
 Double position indicator: head and collar

● Red	NC		STOP - 	LBX14201
● Red	2 NC		STOP - 	LBX14202

Contact blocks fixed behind cover (form p. 90)

Panel cut-out

DRILLING

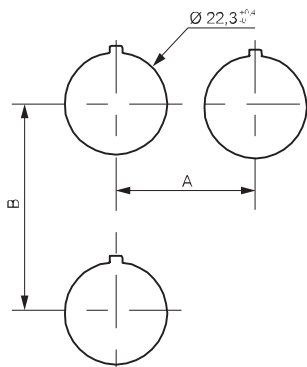

For heads equipped with electrical blocks with screw or plug-in terminals

Minimum interval (mm)

	= 30	With or without legend (usual case)
	= 33	IP 67 (silicon shroud)
	= 40	With large legend plate
A	> 40	For mushroom head \varnothing 40
	> 45	For selector switch with long handle
	= 38	For super-flush button
	= 50	With 5 position clip
B	= 45	With or without legend plate (usual case)
	= 54	With double touch
	= 77	With double touch + legend plate
	= 50	Joystick

DRILLING FOR SUPER-FLUSH BUTTON

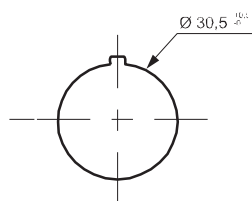

DRILLING WHEN USING THE ANTI-ROTATION RING (OPTIONAL)

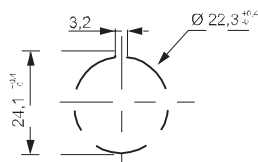

THICKNESS OF PANEL (E)

E = 1 to 6 mm

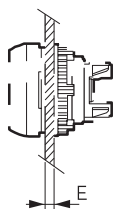

Mounting blocks $\varnothing 22$

NON ILLUMINATED

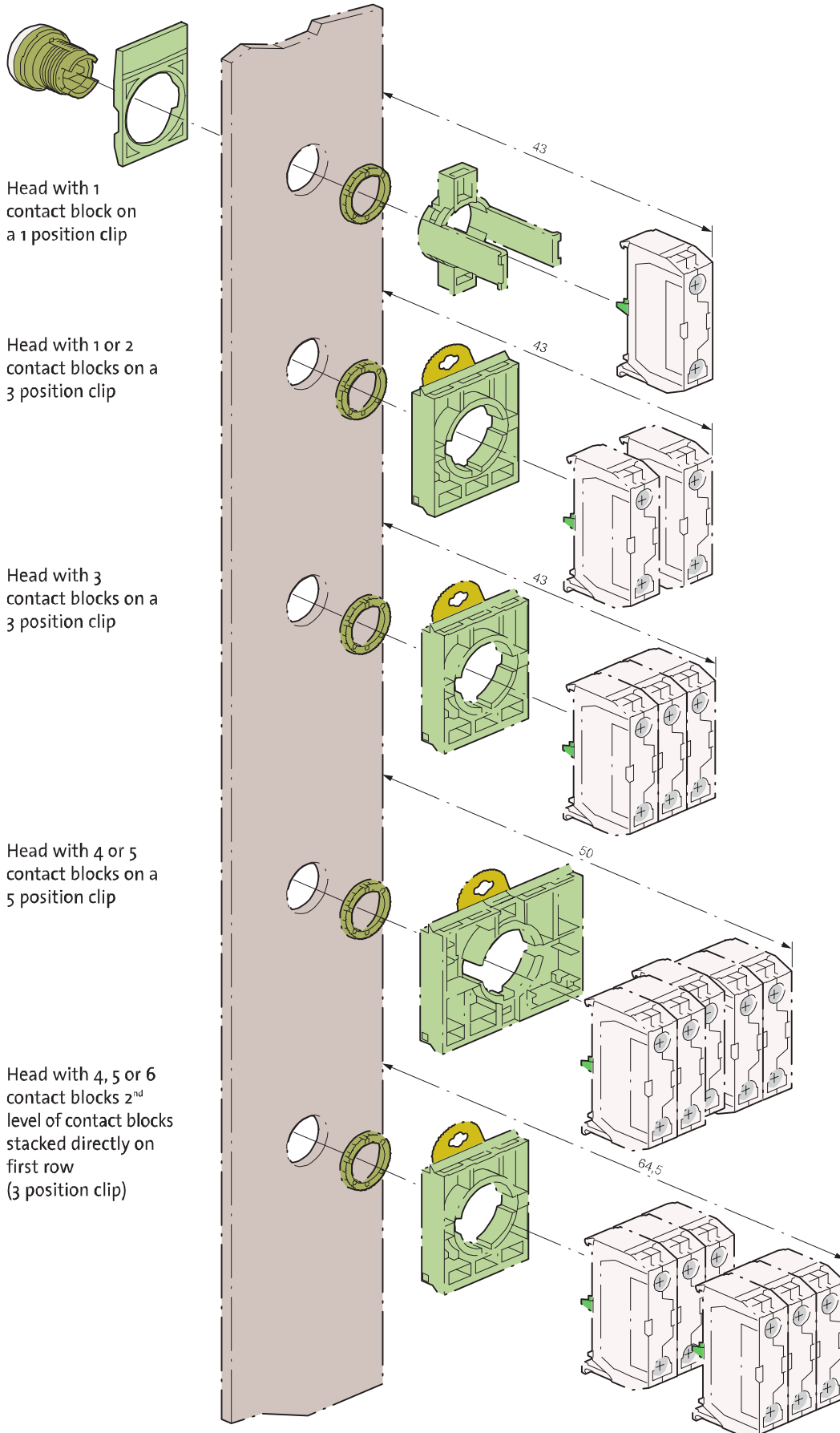

Mounting blocks $\varnothing 22$

ILLUMINATED

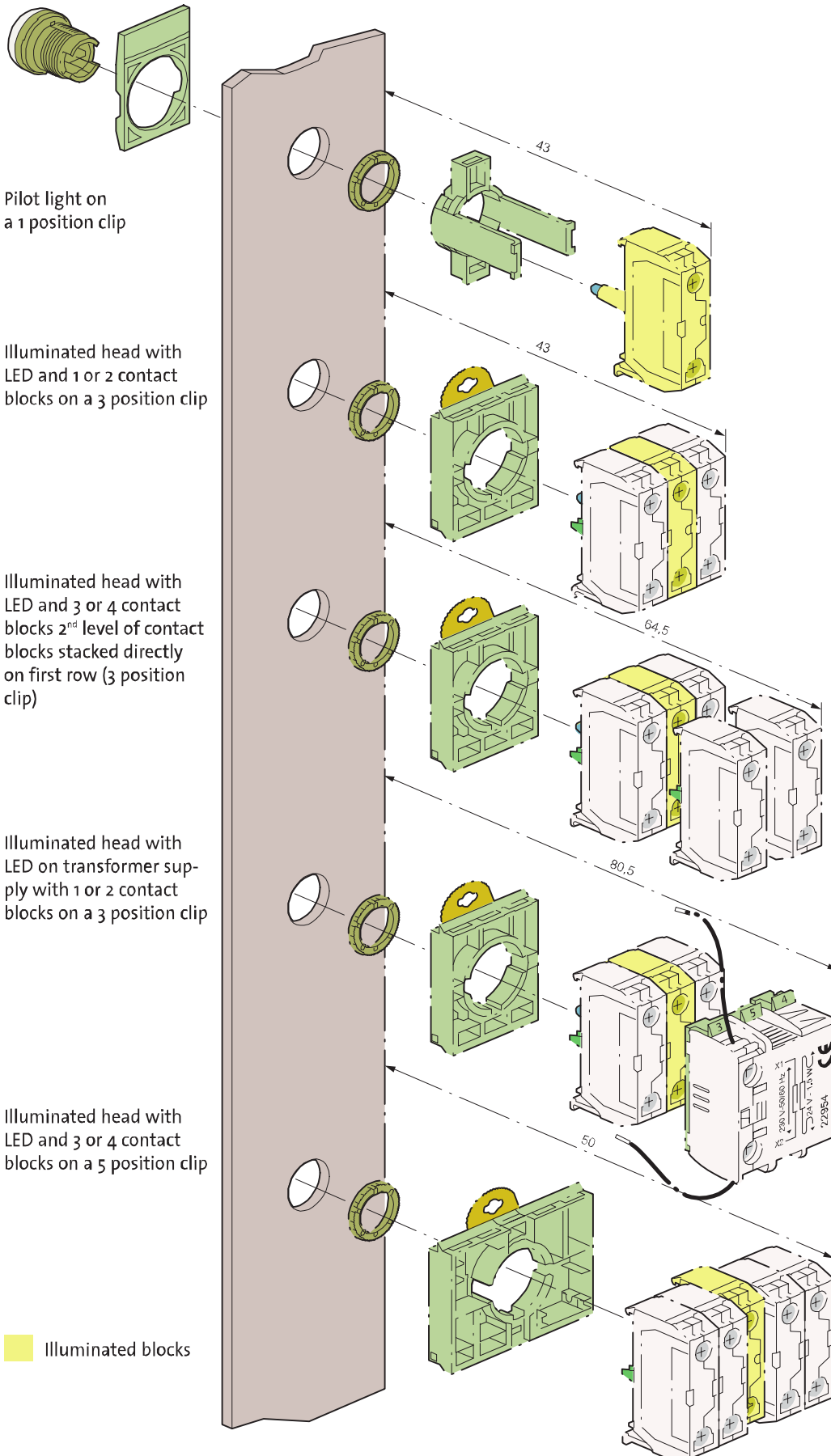

Technical characteristics

▶ GENERAL

Characteristics	Data	Standards
▶ Storage temperature	- 40 °C to + 70 °C	
▶ Operating temperature	- 25 °C to + 70 °C	
▶ Climatic resistance	Constant humid heat Cyclic damp heat Resistance to sea air	IEC 60068-2-3 IEC 60068-2-30 IEC 60068-2-52
▶ Degree of protection	IP 66 for standard heads IP 67 for shrouded heads IP 66 for equipped control stations IP 20 at the rear of the panel for contact blocks and one piece pilot lights Type 1, 2, 3, 3R, 3S, 4, 4X, 12, and 13 for heads and control stations	IEC 60529 NEMA standard
▶ Protection against mechanical impacts	IK 05 illuminated and non illuminated heads IK 07 empty control station	IEC 62262
▶ Electrical insulation	Class II - heads and control station	IEC 60947-5-1
▶ Terminal marking		IEC 60947-1
▶ Tightening torques	Locking ring: recommended 3 N.m terminals: max. 1.2 N.m	
▶ Approvals	UL United states and Canada BV Bureau Véritas Certification OC/CB	UL 508, CSA 22.2 Marine rules IEC 60947-5-1 IEC 60947-5-5 IEC 60947-5-4
▶ Vibrations	withstand vibration Fc test: 2 to 25 Hz, 1.6 mm; 25-100 Hz, 4 g	IEC 60068-2-6

Technical characteristics

▶ CONTACT BLOCKS

Screw and plug-in connection characteristics	Data	Standards	
▶ Rated insulation voltage	690 V AC 600 V AC	IEC/EN 60947-1 UL 508	
▶ NC contacts	Positive opening	IEC/EN 60947-5-1	
▶ Rated impulse voltage U _{imp} Pollution degree	6kV 3		
▶ Conventional thermal current in free air conditions	AC15: 10 A DC13: 2,5 A	IEC 60947-5-1	
▶ Electrical ratings	<p>Alternating current AC15 - A 600 U_e = 120 V, I_e = 6 A U_e = 240 V, I_e = 3 A U_e = 380 V, I_e = 1,9 A U_e = 480 V, I_e = 1,5 A U_e = 500 V, I_e = 1,4 A U_e = 600 V, I_e = 1,2 A</p> <p>Minimum operating current - standard blocks U_e = 24 V DC and I_e = 5 mA Failure rate < 10⁻⁸</p>	<p>Direct current DC13 - Q 600 U_e = 125 V, I_e = 0,55 A U_e = 250 V, I_e = 0,27 A U_e = 400 V, I_e = 0,15 A U_e = 500 V, I_e = 0,13 A U_e = 600 V, I_e = 0,1 A</p> <p>- golden contacts U_e = 5 V DC and I_e = 1 mA Failure rate < 10⁻⁸</p>	IEC 60947-5-1
▶ Electrical operating life	<p>1 million cycles for: - AC15 - B 300 U_e = 120 V, I_e = 3 A U_e = 240 V, I_e = 1,5 A</p>	<p>- DC13 - R 300 U_e = 125 V, I_e = 0,22 A U_e = 250 V, I_e = 0,1 A</p>	
▶ Applicable wire sizes	Rigid or flexible wire without ferrule: 0,5 mm ² to 2 x 2,5 mm ² Rigid or flexible wire with ferrule: 0,5 mm ² to 2 x 1,5 mm ²		
Faston connection	Data	Standards	
▶ Rated insulation voltage	320 V AC 300 V AC	IEC/EN60947-1 UL 508	
▶ NC contacts	Positive opening	IEC/EN 60947-5-1	
▶ Rated impulse withstanding voltage U _{imp} Pollution degree	6 kV 3		
▶ Conventional thermal current in free air conditions	AC 15: 10 A DC 13: 2,5 A	IEC 60947-5-1	
▶ Electrical ratings	<p>Alternating current AC15 - A 300 U_e = 120 V, I_e = 6 A U_e = 240 V, I_e = 3 A</p> <p>Minimum current of use U_e = 24 V DC and I_e = 5 mA Failure rate < 10⁻⁸</p>	<p>Direct current DC13 - Q 300 U_e = 125 V, I_e = 0,55 A U_e = 250 V, I_e = 0,27 A</p> <p>- DC13 - R 300 U_e = 125 V, I_e = 0,22 A U_e = 250 V, I_e = 0,1 A</p>	IEC 60947-5-1
▶ Electrical operating life	<p>1 million cycles for: - AC15 - B 300 U_e = 120 V, I_e = 3 A U_e = 240 V, I_e = 1,5 A</p>	<p>- DC13 - R 300 U_e = 125 V, I_e = 0,22 A U_e = 250 V, I_e = 0,1 A</p>	
▶ Faston size	6,35 mm or 2 x 2,8 mm		

Technical characteristics

▶ CONTACT BLOCKS

Pin-style connection (for PCB)	Data	Standards	
▶ Rated insulation voltage	250 V AC 250 V AC	IEC/EN60947-1 UL 508	
▶ NC contacts	Positive opening	IEC/EN 60947-5-1	
▶ Rated impulse withstanding voltage Uimp Pollution degree	4 kV 3		
▶ Conventional thermal current in free air conditions	AC 15: 5 A DC 13: 1 A	IEC 60947-5-1	
▶ Electrical ratings	Alternating current AC 15 - B 300 Ue = 120 V, Ie = 3 A Ue = 240 V, Ie = 1,5 A	Direct current DC13 - R 300 Ue = 125 V, Ie = 0,22 A Ue = 250 V, Ie = 0,1 A	IEC 60947-5-1 IEC 60947-5-4
	Minimum current of use - standard blocks Ue = 24 V DC and Ie = 5 mA Failure rate < 10 ⁻⁸	- golden contacts Ue = 5 V DC and Ie = 1 mA Failure rate < 10 ⁻⁸	
▶ Electrical operating life	1 million cycles for: - AC15 - B 300 Ue = 120 V, Ie = 3 A Ue = 240 V, Ie = 1,5 A	- DC13 - R 300 Ue = 125 V, Ie = 0,22 A Ue = 250 V, Ie = 0,1 A	
▶ Pin diameter	∅ 1 mm		

▶ LED BLOCKS FOR ILLUMINATED HEADS AND ONE PIECE LED PILOT LIGHTS

Characteristics	Data	Standards
▶ Rated insulation voltage	300 V	IEC/EN 60947-5-1
▶ Rated impulse voltage Uimp Pollution degree	4 kV (with filter block see p. 64) 3	IEC/EN 60947-5-1
▶ Operating voltage	12 to 24 V AC/DC 48 V AC/DC (for LED block) 130 V AC 230 V AC	
▶ Frequency	50 or 60 Hz	
▶ Lifetime at rated supply voltage	Red and yellow: 100 000 hours at 25 °C Other colours: 50 000 hours at 25 °C	
▶ Consumption of LED blocks	Voltage: - 24 V: 25 mA ± 20% - 48 V: 15 mA ± 5% - 130 V: 20 mA ± 10% - 230 V: 16 mA ± 30%	

Technical characteristics

▶ ONE PIECE PILOT LIGHT BA9S

Characteristics	Data	Standards
▶ Rated insulation voltage	400 V	IEC 60947-5-1
▶ Rated impulse withstand voltage Uimp	4 kV	IEC/EN 60947-1
▶ Bulb rating	400 V max. - 2,6 W max. 240 V max. - 2,6 W max.	IEC 60947-5-1 UL 508

▶ HEADS

Characteristics	Data	Standards
▶ Mechanical endurance (in million cycles)	Spring return: 5 Push-push: 0,5 Selector switches: 0,3 Mushroom head maintained function EN 418: 0,10 Mushroom head maintained function: 0,15	
▶ Activation force in N	Spring return + NO: 6,5 Spring return + NC: 4,5 Additional NO contact: 4,5 Additional NC contact: 3,0 Push-pull mushroom head + NO + NC: 27 Push-turn mushroom head + NO + NC: 22 Push-pull mushroom head EN 418 + NO + NC: 37 Push-turn mushroom head EN 418 + NO + NC: 60	
▶ Activation force in Nm	Selector switch + NO: 0,04 Additional NO contact: 0,03	

▶ EMERGENCY STOP ACTUATORS - EN 418:

For equipment subject to Machine Security Directive CE 98/37 and EN60204 standard.

BACO emergency stop switches EN418 and contact blocks meet the requirements of the European Machine Directive EN 418 and EN60947-5-5 specification.

Our E-stops provide the "fool-proof" or "tease-proof" emergency stop switch feature - described below, that latches in the emergency stop command and then switches the contact state to open the circuit and shut down the equipment.

"After the emergency stop command has been generated during actuation of the emergency stop device, the command shall be maintained by engagement (latching-in) of the actuating means. The emergency stop command shall be maintained until the emergency stop device is reset (disengaged). It shall not be possible for the emergency stop device to engage without generating the stop command."

Simply stated, this directive indicates that the latching mechanism of the switch is activated when the actuator is pushed to a certain point. The switch will continue to remain in this latched position until manually reset by twisting to release.

Diagrams

MECHANICAL OPERATION

For 3 position selector switches

Handle position
(front side view)

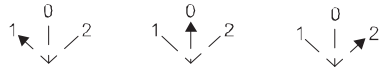

Contacts block actuation
(back view)



Back side view

Non operated block



Operated block



MECHANICAL OPERATION

For Joysticks

2 positions

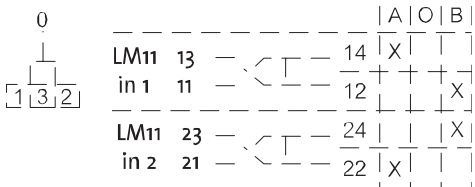

4 positions

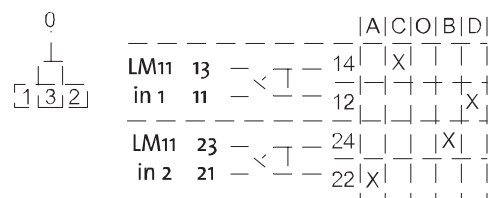

PUSH-TO-TEST LED PILOT LIGHT DIAGRAMS

Lamp-testing module with
1 diode (33ET) for direct
supply 24 V and 48 V

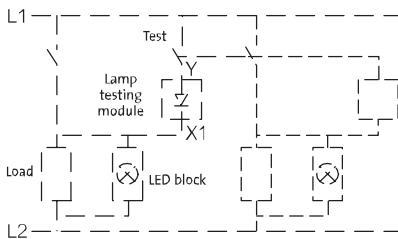

Lamp-testing module with
2 diodes (33ETT) for direct
supply 24 V and 48 V

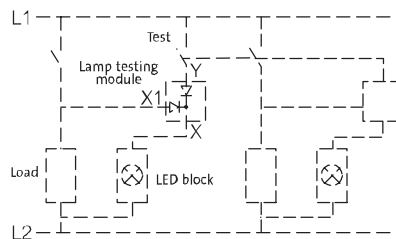

Lamp-testing assembly
for direct supply 130 V and 240 V
(Consult us - see page 79)

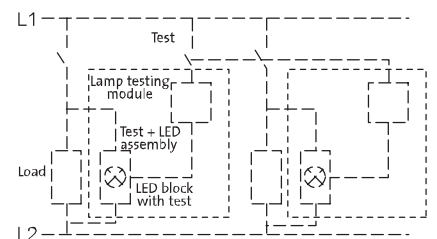

PRINTED CIRCUIT BOARD MOUNTING

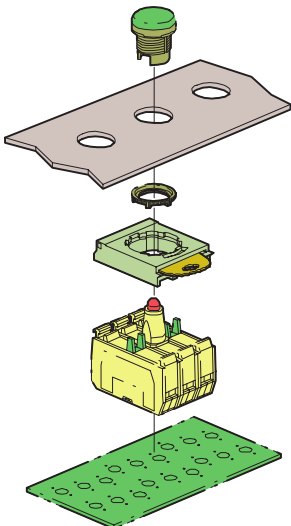

Gehäuse Ø 22

IP 66
 Kontakte: Bodenbefestigung mit Schraubanschluss
 Nach Norm EN-IEC 60947-5-1
 Mit 2 vorgepressten Ausbruchstellen ISO - 1620

 Technische Daten (Seite 94)
 Vergleichstabelle (Seite 311)

► GEHÄUSE MIT 1 TASTER (FORTSETZUNG)

NOT-AUS TASTER Ø 40 EN-418/ISO 13850 - RASTEND

Zugentriegelung

Bestell-Nr.



LBX15101

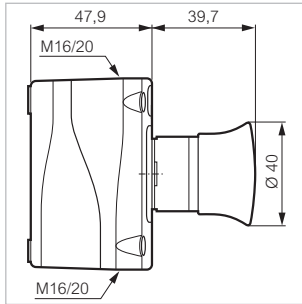

Überlistungssicher nach IEC 60947-5-5 /EN418/ISO 13850

	Kontakt	Bezeichnung	Bestell-Nr.
● Rot	NC	ARRET D'URGENCE	LBX15101
● Rot	2 NC	ARRET D'URGENCE	LBX15102
● Rot	NC	NOT- AUS	LBX15201
● Rot	2 NC	NOT- AUS	LBX15202
● Rot	NC	EMERGENCY STOP	LBX15301
● Rot	2 NC	EMERGENCY STOP	LBX15302

Kontakt hinter Deckel befestigt (Formular Seite 90)

NOT-AUS TASTER MIT SCHLÜSSEL, Ø 40 EN 418 /ISO 13850 - RASTEND

Schlüsselentriegelung

Bestell-Nr.



LBX11302

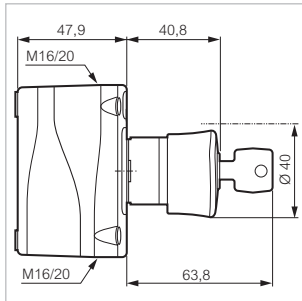

Überlistungssicher nach IEC 60947-5-5 /EN418/ISO 13850
 Lieferung mit 2 Schlüsseln Nr. 455

	Kontakt	Bezeichnung	Bestell-Nr.
● Rot	NC	ARRET D'URGENCE	LBX11101
● Rot	2 NC	ARRET D'URGENCE	LBX11102
● Rot	NC	NOT- AUS	LBX11201
● Rot	2 NC	NOT- AUS	LBX11202
● Rot	NC	EMERGENCY STOP	LBX11301
● Rot	2 NC	EMERGENCY STOP	LBX11302

Kontakt hinter Deckel befestigt (Formular Seite 90)

NOT-AUS TASTER Ø 54 EN 418/ISO 13850 - RASTEND

Zugentriegelung mit Zustandsanzeige

Bestell-Nr.



LBX14201

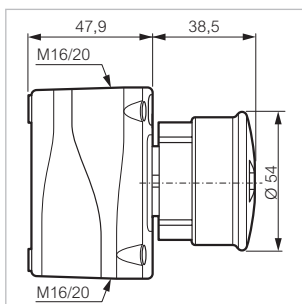

Überlistungssicher nach IEC 60947-5-5 /EN418/ISO 13850
 Doppelte Zustandsanzeige: mittels gelben Ring und im Sichtfenster

	Kontakt	Bezeichnung	Bestell-Nr.
● Rot	NC	STOP - (I)	LBX14201
● Rot	2 NC	STOP - (I)	LBX14202

Kontakt hinter Deckel befestigt (Formular Seite 90)

Separate units \varnothing 22: Heads

IP 66
 To be combined with a clip and electrical blocks (p. 48)
 Equipped with a locking ring
 Plastic black bezel
 Conform to IEC 60947-5-1

 Characteristics (p. 94)
 Cross reference list (p. 311)

► EN 418/ISO 13850 EMERGENCY STOP - NON ILLUMINATED (CONTINUED)

\varnothing 40 EN 418/ISO 13850 - STAY-PUT

Push-pull to reset

Cat. No.



L22DR01

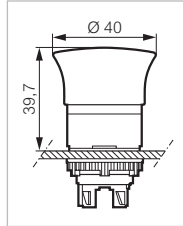

Head position visible from the side with yellow collar
 Compliant with the requirements of emergency stop:
 IEC 60947-5-5 / EN 418/ISO 13850

● Red

L22DR01

\varnothing 40 EN 418/ISO 13850 - STAY-PUT

Push-turn to reset



L22ER01

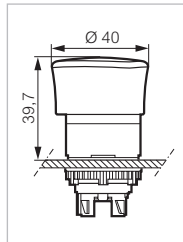

Head position visible from the side with yellow collar
 Compliant with the requirements of emergency stop:
 IEC 60947-5-5 / EN 418/ISO 13850

● Red

L22ER01

\varnothing 40 EN 418/ISO 13850 - STAY-PUT

Key to reset



L22GR01

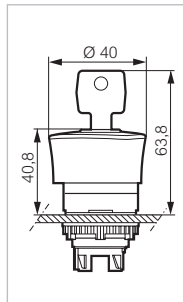

Supplied with 2 keys profile n° 455
 Head position visible from the side with yellow collar
 Compliant with the requirements of emergency stop:
 IEC 60947-5-5 / EN 418/ISO 13850

● Red

L22GR01

\varnothing 54 EN 418/ISO 13850 - STAY-PUT

Push-pull to reset with flag indicator



L22DU01

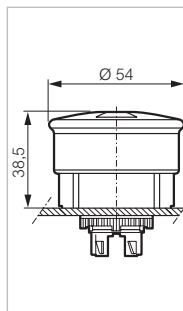

Double position indicator: head and collar
 Compliant with the requirements of emergency stop:
 IEC 60947-5-5 / EN 418/ISO 13850

● Red - engraving O - I
 ● Red - engraving STOP - I

L22DU01A
L22DU01

Panel cut-out

DRILLING

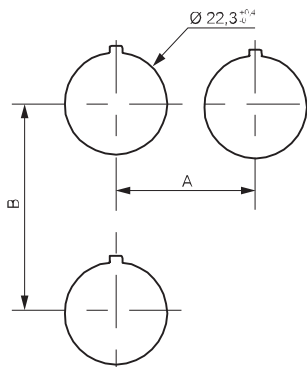

For heads equipped with electrical blocks with screw or plug-in terminals

Minimum interval (mm)

	= 30	With or without legend (usual case)
	= 33	IP 67 (silicon shroud)
	= 40	With large legend plate
A	> 40	For mushroom head \varnothing 40
	> 45	For selector switch with long handle
	= 38	For super-flush button
	= 50	With 5 position clip
B	= 45	With or without legend plate (usual case)
	= 54	With double touch
	= 77	With double touch + legend plate
	= 50	Joystick

DRILLING FOR SUPER-FLUSH BUTTON

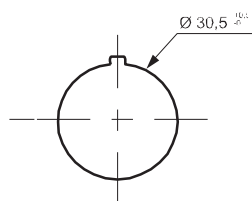

DRILLING WHEN USING THE ANTI-ROTATION RING (OPTIONAL)

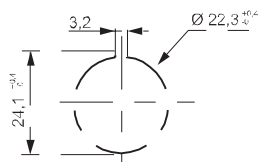

THICKNESS OF PANEL (E)

E = 1 to 6 mm

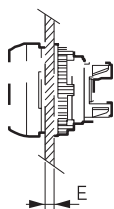

Mounting blocks $\varnothing 22$

NON ILLUMINATED

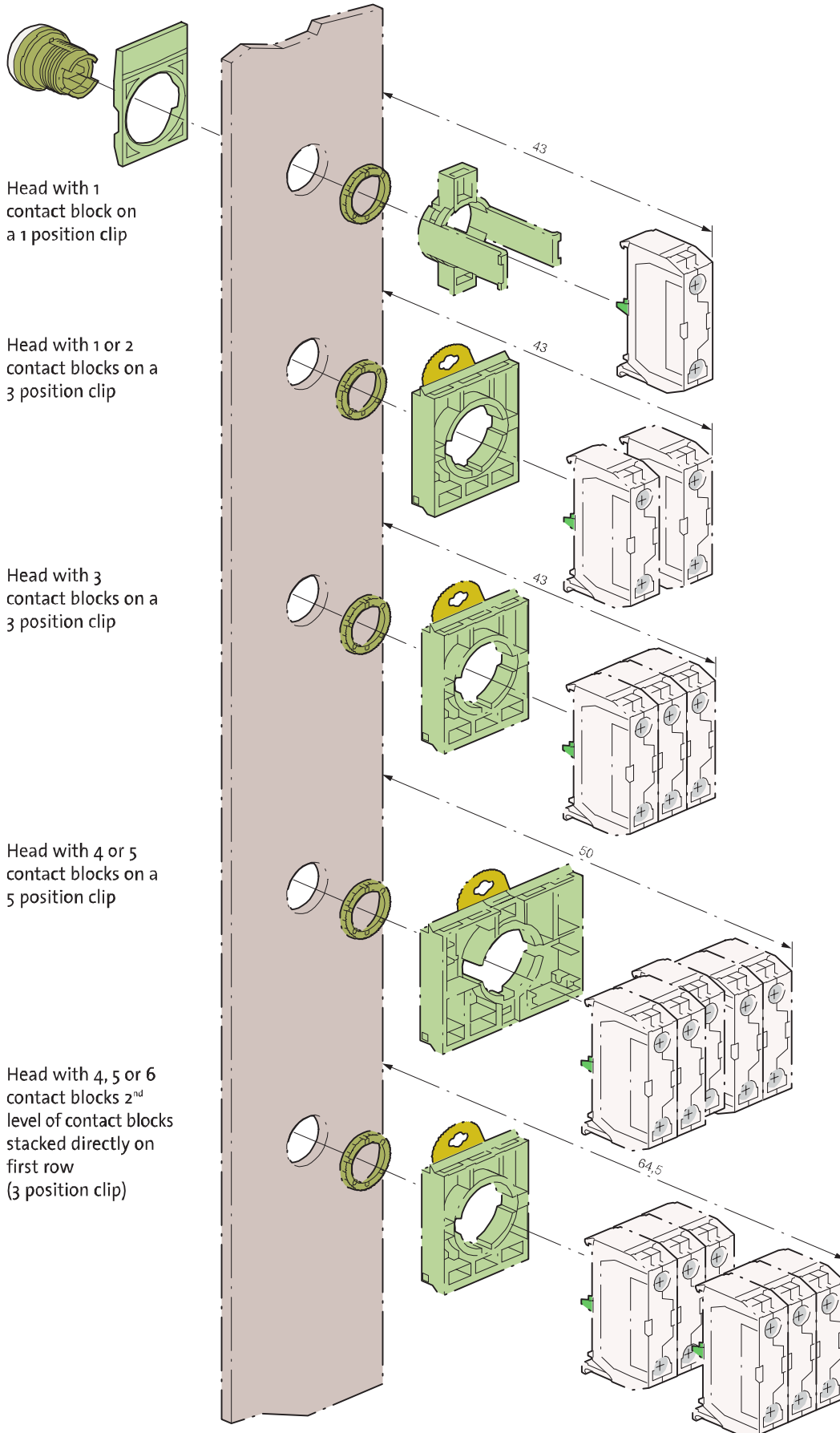

Mounting blocks $\varnothing 22$

ILLUMINATED

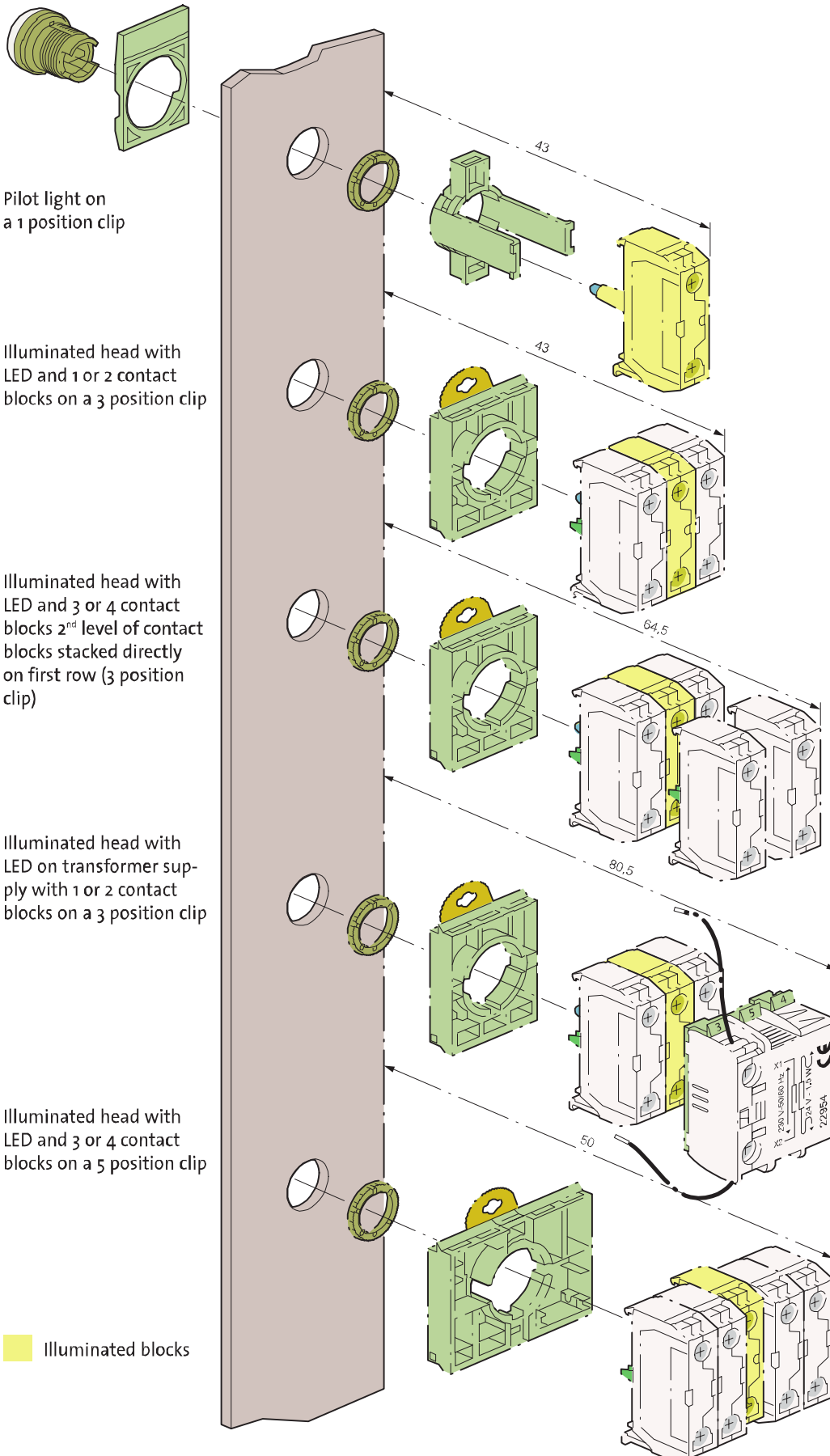

Technical characteristics

▶ GENERAL

Characteristics	Data	Standards
▶ Storage temperature	- 40 °C to + 70 °C	
▶ Operating temperature	- 25 °C to + 70 °C	
▶ Climatic resistance	Constant humid heat Cyclic damp heat Resistance to sea air	IEC 60068-2-3 IEC 60068-2-30 IEC 60068-2-52
▶ Degree of protection	IP 66 for standard heads IP 67 for shrouded heads IP 66 for equipped control stations IP 20 at the rear of the panel for contact blocks and one piece pilot lights Type 1, 2, 3, 3R, 3S, 4, 4X, 12, and 13 for heads and control stations	IEC 60529 NEMA standard
▶ Protection against mechanical impacts	IK 05 illuminated and non illuminated heads IK 07 empty control station	IEC 62262
▶ Electrical insulation	Class II - heads and control station	IEC 60947-5-1
▶ Terminal marking		IEC 60947-1
▶ Tightening torques	Locking ring: recommended 3 N.m terminals: max. 1.2 N.m	
▶ Approvals	UL United states and Canada BV Bureau Véritas Certification OC/CB	UL 508, CSA 22.2 Marine rules IEC 60947-5-1 IEC 60947-5-5 IEC 60947-5-4
▶ Vibrations	withstand vibration Fc test: 2 to 25 Hz, 1.6 mm; 25-100 Hz, 4 g	IEC 60068-2-6

Technical characteristics

▶ CONTACT BLOCKS

Screw and plug-in connection characteristics	Data	Standards	
▶ Rated insulation voltage	690 V AC 600 V AC	IEC/EN 60947-1 UL 508	
▶ NC contacts	Positive opening	IEC/EN 60947-5-1	
▶ Rated impulse voltage U _{imp} Pollution degree	6kV 3		
▶ Conventional thermal current in free air conditions	AC15: 10 A DC13: 2,5 A	IEC 60947-5-1	
▶ Electrical ratings	<p>Alternating current AC15 - A 600 U_e = 120 V, I_e = 6 A U_e = 240 V, I_e = 3 A U_e = 380 V, I_e = 1,9 A U_e = 480 V, I_e = 1,5 A U_e = 500 V, I_e = 1,4 A U_e = 600 V, I_e = 1,2 A</p> <p>Minimum operating current - standard blocks U_e = 24 V DC and I_e = 5 mA Failure rate < 10⁻⁸</p>	<p>Direct current DC13 - Q 600 U_e = 125 V, I_e = 0,55 A U_e = 250 V, I_e = 0,27 A U_e = 400 V, I_e = 0,15 A U_e = 500 V, I_e = 0,13 A U_e = 600 V, I_e = 0,1 A</p> <p>- golden contacts U_e = 5 V DC and I_e = 1 mA Failure rate < 10⁻⁸</p>	IEC 60947-5-1
▶ Electrical operating life	<p>1 million cycles for: - AC15 - B 300 U_e = 120 V, I_e = 3 A U_e = 240 V, I_e = 1,5 A</p>	<p>- DC13 - R 300 U_e = 125 V, I_e = 0,22 A U_e = 250 V, I_e = 0,1 A</p>	
▶ Applicable wire sizes	Rigid or flexible wire without ferrule: 0,5 mm ² to 2 x 2,5 mm ² Rigid or flexible wire with ferrule: 0,5 mm ² to 2 x 1,5 mm ²		
Faston connection	Data	Standards	
▶ Rated insulation voltage	320 V AC 300 V AC	IEC/EN60947-1 UL 508	
▶ NC contacts	Positive opening	IEC/EN 60947-5-1	
▶ Rated impulse withstanding voltage U _{imp} Pollution degree	6 kV 3		
▶ Conventional thermal current in free air conditions	AC 15: 10 A DC 13: 2,5 A	IEC 60947-5-1	
▶ Electrical ratings	<p>Alternating current AC15 - A 300 U_e = 120 V, I_e = 6 A U_e = 240 V, I_e = 3 A</p> <p>Minimum current of use U_e = 24 V DC and I_e = 5 mA Failure rate < 10⁻⁸</p>	<p>Direct current DC13 - Q 300 U_e = 125 V, I_e = 0,55 A U_e = 250 V, I_e = 0,27 A</p> <p>- DC13 - R 300 U_e = 125 V, I_e = 0,22 A U_e = 250 V, I_e = 0,1 A</p>	IEC 60947-5-1
▶ Electrical operating life	<p>1 million cycles for: - AC15 - B 300 U_e = 120 V, I_e = 3 A U_e = 240 V, I_e = 1,5 A</p>	<p>- DC13 - R 300 U_e = 125 V, I_e = 0,22 A U_e = 250 V, I_e = 0,1 A</p>	
▶ Faston size	6,35 mm or 2 x 2,8 mm		

Technical characteristics

▶ CONTACT BLOCKS

Pin-style connection (for PCB)	Data	Standards	
▶ Rated insulation voltage	250 V AC 250 V AC	IEC/EN60947-1 UL 508	
▶ NC contacts	Positive opening	IEC/EN 60947-5-1	
▶ Rated impulse withstanding voltage Uimp Pollution degree	4 kV 3		
▶ Conventional thermal current in free air conditions	AC 15: 5 A DC 13: 1 A	IEC 60947-5-1	
▶ Electrical ratings	Alternating current AC 15 - B 300 Ue = 120 V, Ie = 3 A Ue = 240 V, Ie = 1,5 A	Direct current DC13 - R 300 Ue = 125 V, Ie = 0,22 A Ue = 250 V, Ie = 0,1 A	IEC 60947-5-1 IEC 60947-5-4
	Minimum current of use - standard blocks Ue = 24 V DC and Ie = 5 mA Failure rate < 10 ⁻⁸	- golden contacts Ue = 5 V DC and Ie = 1 mA Failure rate < 10 ⁻⁸	
▶ Electrical operating life	1 million cycles for: - AC15 - B 300 Ue = 120 V, Ie = 3 A Ue = 240 V, Ie = 1,5 A	- DC13 - R 300 Ue = 125 V, Ie = 0,22 A Ue = 250 V, Ie = 0,1 A	
▶ Pin diameter	∅ 1 mm		

▶ LED BLOCKS FOR ILLUMINATED HEADS AND ONE PIECE LED PILOT LIGHTS

Characteristics	Data	Standards
▶ Rated insulation voltage	300 V	IEC/EN 60947-5-1
▶ Rated impulse voltage Uimp Pollution degree	4 kV (with filter block see p. 64) 3	IEC/EN 60947-5-1
▶ Operating voltage	12 to 24 V AC/DC 48 V AC/DC (for LED block) 130 V AC 230 V AC	
▶ Frequency	50 or 60 Hz	
▶ Lifetime at rated supply voltage	Red and yellow: 100 000 hours at 25 °C Other colours: 50 000 hours at 25 °C	
▶ Consumption of LED blocks	Voltage: - 24 V: 25 mA ± 20% - 48 V: 15 mA ± 5% - 130 V: 20 mA ± 10% - 230 V: 16 mA ± 30%	

Technical characteristics

▶ ONE PIECE PILOT LIGHT BA9S

Characteristics	Data	Standards
▶ Rated insulation voltage	400 V	IEC 60947-5-1
▶ Rated impulse withstand voltage Uimp	4 kV	IEC/EN 60947-1
▶ Bulb rating	400 V max. - 2,6 W max. 240 V max. - 2,6 W max.	IEC 60947-5-1 UL 508

▶ HEADS

Characteristics	Data	Standards
▶ Mechanical endurance (in million cycles)	Spring return: 5 Push-push: 0,5 Selector switches: 0,3 Mushroom head maintained function EN 418: 0,10 Mushroom head maintained function: 0,15	
▶ Activation force in N	Spring return + NO: 6,5 Spring return + NC: 4,5 Additional NO contact: 4,5 Additional NC contact: 3,0 Push-pull mushroom head + NO + NC: 27 Push-turn mushroom head + NO + NC: 22 Push-pull mushroom head EN 418 + NO + NC: 37 Push-turn mushroom head EN 418 + NO + NC: 60	
▶ Activation force in Nm	Selector switch + NO: 0,04 Additional NO contact: 0,03	

▶ EMERGENCY STOP ACTUATORS - EN 418:

For equipment subject to Machine Security Directive CE 98/37 and EN60204 standard.

BACO emergency stop switches EN418 and contact blocks meet the requirements of the European Machine Directive EN 418 and EN60947-5-5 specification.

Our E-stops provide the "fool-proof" or "tease-proof" emergency stop switch feature - described below, that latches in the emergency stop command and then switches the contact state to open the circuit and shut down the equipment.

"After the emergency stop command has been generated during actuation of the emergency stop device, the command shall be maintained by engagement (latching-in) of the actuating means. The emergency stop command shall be maintained until the emergency stop device is reset (disengaged). It shall not be possible for the emergency stop device to engage without generating the stop command."

Simply stated, this directive indicates that the latching mechanism of the switch is activated when the actuator is pushed to a certain point. The switch will continue to remain in this latched position until manually reset by twisting to release.

Diagrams

MECHANICAL OPERATION

For 3 position selector switches

Handle position
(front side view)

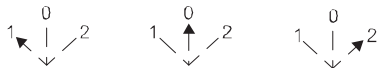

Contacts block actuation
(back view)



Back side view

Non operated block

Operated block



MECHANICAL OPERATION

For Joysticks

2 positions

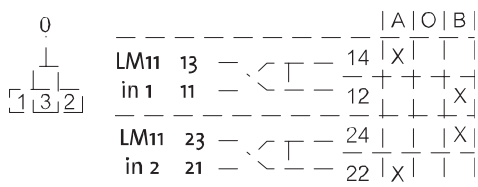

4 positions

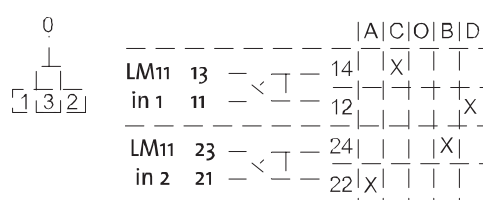

PUSH-TO-TEST LED PILOT LIGHT DIAGRAMS

Lamp-testing module with
1 diode (33ET) for direct
supply 24 V and 48 V

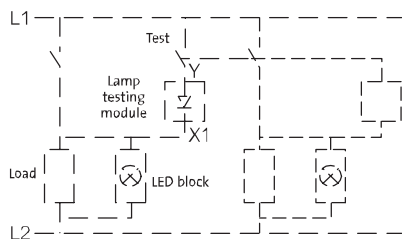

Lamp-testing module with
2 diodes (33ETT) for direct
supply 24 V and 48 V

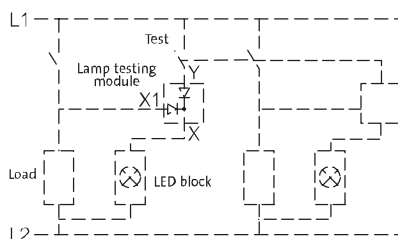

Lamp-testing assembly
for direct supply 130 V and 240 V
(Consult us - see page 79)

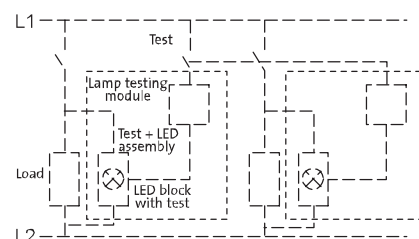

PRINTED CIRCUIT BOARD MOUNTING

