

Klemmenblock Type E nach UL 508 für
Leistungsschalter Baugröße S00/S0



Allgemeine technische Daten:

Produkt-Markename		SIRIUS
Produkt-Bezeichnung		Klemmenblock
Ausführung des Produkts		Type E
Baugröße des Leistungsschalters		S00, S0
Schutzart IP frontseitig		IP20
Isolationsspannung bei Verschmutzungsgrad 3 Bemessungswert	V	690
Umgebungstemperatur		
• während Lagerung	°C	-50 ... +80
• während Betrieb	°C	-20 ... +60
Strombelastbarkeit maximal	A	40





Einbau/ Befestigung/ Abmessungen:

Breite	mm	44,8
Höhe	mm	38,9
Tiefe	mm	73,6
Eignung zur Verwendung ermöglicht Aufbau von Self Protected Combination Motor Controller (Type E) nach UL 508 Anmerkung		Ein Aufbau mit Sammelschienen 3RV1915 ist nicht möglich

Anschlüsse/ Klemmen:

Ausführung des elektrischen Anschlusses für Hauptstromkreis		Schraubanschluss
Art der anschließbaren Leiterquerschnitte		
<ul style="list-style-type: none"> • für Hauptkontakte <ul style="list-style-type: none"> — eindrätig — mehrdrätig — feindrätig <ul style="list-style-type: none"> — mit Aderendbearbeitung • bei AWG-Leitungen für Hauptkontakte 		2x (1 ... 10 mm ²) 2x (2,5 ... 16 mm ²), 1x (1,5 ... 25) 1x (1 ... 16 mm ²), 2x (1 ... 10 mm ²) 1x (14 ... 3), 1x (16 ... 3), (14 ... 6), (16 ... 3)

Approbationen/ Zertifikate:

Eignungsnachweis		CE / UL / CSA / CCC	
allgemeine Produktzulassung	Konformitätserklärung	Prüfbescheinigungen	Schiffbau
 CSA		 EG-Konf.	spezielle Prüfbescheinigungen Typprüfbescheinigung/Werkszeugnis  ABS

Schiffbau	sonstiges
 BUREAU VERITAS  LRS  PRS  RINA  RMRS	Bestätigungen

sonstiges	Railway
 VDE	Schwingen / Schocken

Weitere Informationen

Information- and Downloadcenter (Kataloge, Broschüren,...)

<http://www.siemens.de/industrial-controls/catalogs>

Industry Mall (Online-Bestellsystem)

<http://www.siemens.com/industrymall>

CAX-Online-Generator

<http://support.automation.siemens.com/WW/CAXorder/default.aspx?lang=de&mfb=3RV2928-1H>

Service&Support (Handbücher, Betriebsanleitungen, Zertifikate, Kennlinien, FAQs,...)

<https://support.industry.siemens.com/cs/ww/de/ps/3RV2928-1H>

Bilddatenbank (Produktfotos, 2D-Maßzeichnungen, 3D-Modelle, Geräteschaltpläne, EPLAN Makros, ...)

http://www.automation.siemens.com/bilddb/cax_de.aspx?mfb=3RV2928-1H&lang=de

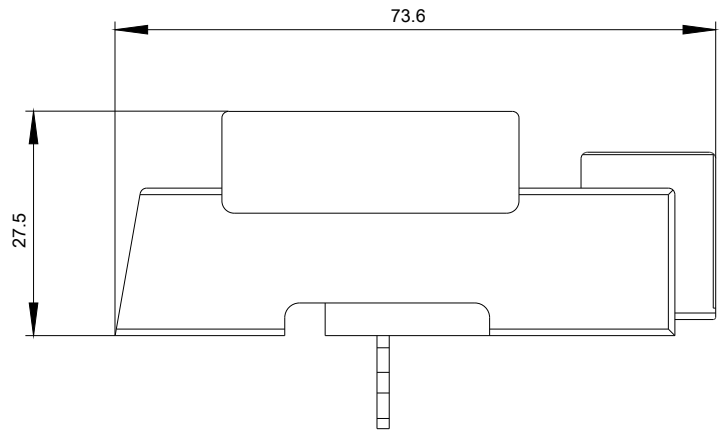
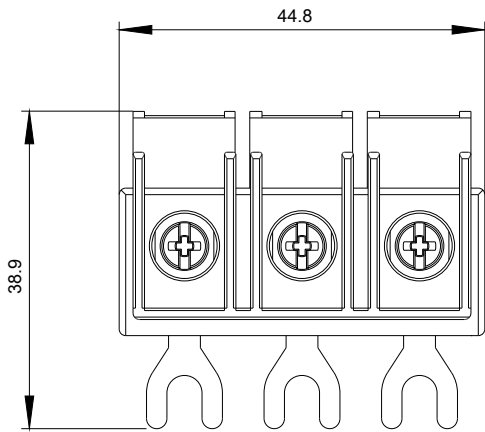

letzte Änderung:

29.06.2018