

Verbindungsbaustein elektrisch und mechanisch für  
3RV2.3 und 3RT2.3. (Mehrstückverpackung)







Abbildung ähnlich

Allgemeine technische Daten		
Produkt-Markename		SIRIUS
Produkt-Bezeichnung		Verbindungsbaustein
Baugröße des Leistungsschalters		S2
Baugröße des Schützes		S2
Produktbestandteil Verdrahtungsbaustein unten		Nein
Produktbestandteil Verdrahtungsbaustein oben		Nein
Einbau/ Befestigung/ Abmessungen		
Befestigungsart		Schraubbefestigung
Approbationen/Zertifikate		

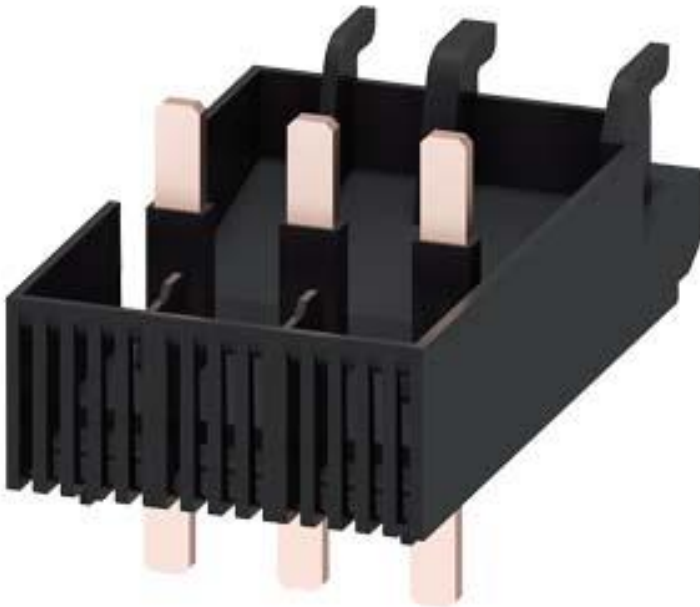
allgemeine Produktzulassung			Konformitätserklärung	Prüfbescheinigungen	
 CSA	 UL		 EG-Konf.	<a href="#">Typprüfbescheinigung/Werkszeugnis</a>	<a href="#">spezielle Prüfbescheinigungen</a>

Schiffbau					sonstiges
 ABS	 BUREAU VERITAS	 GL	 PRS	 RINA	<a href="#">Bestätigungen</a>

## Weitere Informationen

### Information- and Downloadcenter (Kataloge, Broschüren,...)

<http://www.siemens.de/industrial-controls/catalogs>

### Industry Mall (Online-Bestellsystem)

<https://mall.industry.siemens.com/mall/de/de/Catalog/product?mlfb=3RA2931-1A>

### CAX-Online-Generator

<http://support.automation.siemens.com/WW/CAXorder/default.aspx?lang=de&mlfb=3RA2931-1A>

### Service&Support (Handbücher, Betriebsanleitungen, Zertifikate, Kennlinien, FAQs,...)

<https://support.industry.siemens.com/cs/ww/de/ps/3RA2931-1A>

### Bilddatenbank (Produktfotos, 2D-Maßzeichnungen, 3D-Modelle, Geräteschaltpläne, EPLAN Makros, ...)

[http://www.automation.siemens.com/bilddb/cax\\_de.aspx?mlfb=3RA2931-1A&lang=de](http://www.automation.siemens.com/bilddb/cax_de.aspx?mlfb=3RA2931-1A&lang=de)

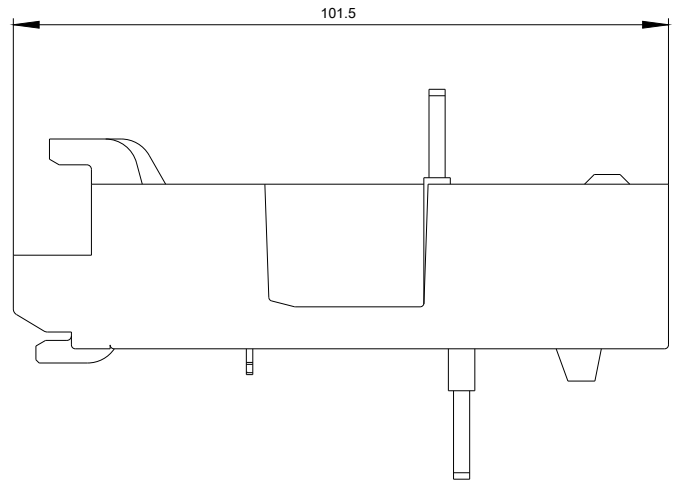
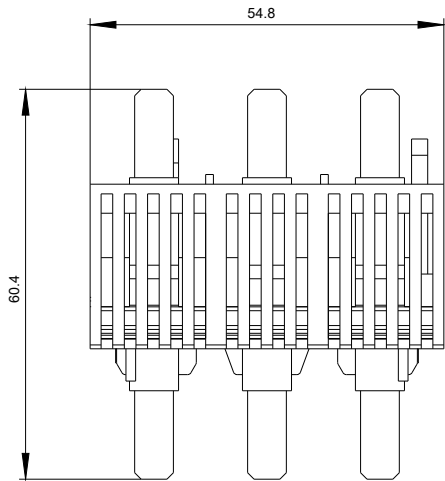

letzte Änderung:

18.07.2018